



SHEET RUBBER & FLUID SEALING PRODUCTS





INDEPENDENCE RAGCO stores are independently owned & operated small businesses. Our affiliates run their business to best suit the customers in their respective markets. They are not beholden to a national sales plan or corporate masters.

EXPERIENCE RAGCO stores experience remarkably low turnover thanks to great employee relations. Each store offers individuals with decades of experience in the rubber industry.

QUALITY Factory training. Trade organization support. Measureable results. Repeatable success. RAGCO's partners support our members with the most technologically advanced training available, and industry trade organizations like NAHAD, NIBA, and FSA play an important role in members' systems.

SERVICE The forgotten aspect of today marketplace? Not at your local RAGCO location. Our customers come first always. Period.

RESPONSIVENESS Fast answers, quick turn-around, prompt service after the sale.

COMPETITIVENESS The RAGCO group's purchasing power gives each individual store, large or small, highly aggressive pricing to ensure competitive solutions for their respective markets.

FABRICATION Gasket fabrication, waterjet cutting, air-knife cutting, die-press cutting, slitting, CAD, molded & moldless products, vulcanization, extrusion, and much more! RAGCO stores can customize materials per your specifications.

NETWORKING RAGCO members meet regularly to exchange ideas, share problems and solutions, and nurture lifelong friendships.

RELATIONSHIPS RAGCO holds agreements with the finest manufacturers in the world including Garlock, American Biltrite, Unaflex, ThermoSeal, American Braiding, and more...

TRADITION Decades and decades of success in the rubber & fluid sealing industry are being reinforced by the people who make RAGCO great. Second and third generations of families continue to strive for excellence in our changing economy.

TABLE OF CONTENTS

SHEET RUBBER4

Neoprene	4
Slab Neoprene.....	5
Red Rubber	6
Gum Rubber	7
EPDM.....	8
Cloth Inserted Rubber	9
Nitrile.....	10
White FDA Nitrile	11
Viton®	12
Hypalon®.....	12
Silicone	13
Butyl	13
Sponge.....	14
Cork (Neoprene/Buna)	17
AASHTO Bearing Pad	18
Skirtboard Rubber.....	19

COMPRESSED GASKET SHEET20

Green General Purpose Gasket Sheet.....	20
Compressed Gasket Sheet with SBR Binder.....	20
Compressed Gasket Sheet with Neoprene Binder.....	21
Compressed Gasket Sheet with EPDM Binder	21
Inorganic Fiber Gasket Sheet	22
Oil Paper / Vegetable Fiber	22
High Temp Compressed Sheet (Graphite w/ nitrile binder, Carbon w/ nitrile binder).....	23
Graphite Gasket Sheet.....	24
PTFE Gasket Products.....	26
PTFE (Teflon ®).....	32
PTFE Joint Sealant (Sealex ®)	33
Commercial Flange Dimensions.....	35

METAL & BOILER GASKETS42

Spiral Wound Gasket (CG, CGI, R, RIR)	42
Spiral Wound Hand-Hole & Manway Gasket.....	48
Self-Locator Gaskets	51
Topog-E® Gaskets.....	52

BRAIDED PACKING58

921	58
3000G	58
3000T	59
300	59
344	60



* RAGCO supports the autonomy of its locations to select the best products to service their markets. Subtle variations of these specification may exist. Contact your RAGCO affiliate for confirmation.

344BIL.....	60
344FDA.....	61
345.....	61
3030INA.....	62
4000.....	62
4000G.....	63
5000.....	63
5000IJ.....	64
8000LC.....	64
8000T.....	65
8200BIL.....	65

O-RING & O-RING CORD.....66

Nitrile O-ring Overview.....	66
Nitrile-70 O-ring.....	68
Nitrile-90 O-ring.....	69
Viton O-ring Overview.....	70
Viton-75 O-ring.....	72
Viton-90 O-ring.....	73
Neoprene-70 O-ring.....	74
EPDM-70 O-ring.....	76
Silicone-70 O-ring.....	78
Teflon O-ring.....	81
Polyurethane O-ring Overview.....	83
Polyurethane-70 O-ring.....	84
Polyurethane-90 O-ring.....	85
Standard O-Ring Chart.....	86
O-ring Cord.....	96
O-Ring Kits.....	97
<i>Standard</i>	97
<i>Metric</i>	98
<i>Splicing</i>	99

INFORMATION.....100

Sheet Rubber General Properties.....	100
Sheet Rubber Thickness Tolerances.....	101
Storage Of Rubber Products.....	102
SAE Shelf Life.....	103
Torque Tables.....	104
Metric Conversions.....	105

NEOPRENE



A general purpose compound with low temperature flexibility and oil resistance. Resists rotting, checking, and cracking due to weather exposure. Commonly used for gaskets, sealing, skirting, cushioning, or stripping rubber material. Great for rubber washers and bushings.

ADVANTAGES Good inherent flame resistance; moderate resistance to oil and gasoline; excellent adhesion to fabrics and metals; very good resistance to weather, ozone and natural aging; good resistance to abrasion and flex cracking; very good resistance to alkalis and acids.

LIMITATIONS Poor to fair resistance to aromatic and oxygenated solvents; limited ability at low temperatures.

APPLICATIONS Where mild oil resistance and weathering properties are both required (gaskets and washers, seals for doors and windows).

DUROMETER HARDNESS (SHORE A ± 5)	THICKNESS (INCHES)	AVAILABLE WIDTHS (INCHES)	TENSILE (MIN. PSI)	ULTIMATE ELONGATION (MIN. %)	TEMPERATURE RANGE	ESTIMATED WEIGHT PER LINEAR FOOT (1/8" X 36")	SPECIFICATIONS
40	1/16 - 2	36, 48	800	350	-20°F to 170°F	2.5 lb	ASTM D 2000 1BC 408 SAE J200 1BC 408 MIL R 3065 SC 408 Z1
50	1/32 - 2	36, 48, 72	800	300	-20°F to 170°F	2.6 lb	ASTM D 2000 1BC 508 SAE J200 1BC 508 MIL R 3065 SC 508 Z1
60	1/32 - 2	36, 48, 72	900	300	-20°F to 170°F	2.7 lb	ASTM D 2000 1BC 609 SAE J200 1BC 609 MIL R 3065 SC 609 Z1
70	1/32 - 2	36, 48, 72	1000	200	-20°F to 170°F	2.7 lb	ASTM D 2000 1BC 710 SAE J200 1BC 710 MIL R 3065 SC 710 Z1
80	1/32 - 2	36, 48, 72	1000	100	-20°F to 170°F	2.8 lb	ASTM D 2000 1BC 810 SAE J200 1BC 810 MIL R 3065 SC 810 Z1

*Tables display most prevalent versions of material. Unlisted durometers and manipulations to these specification can be custom manufactured.



SLAB NEOPRENE

High-grade commercial neoprene offered in heavy gauges. These high-quality slabs lay flat, rather than bent or rolled, to make cutting easier. Used for machinery mounting pads, wear strips, shock pads and where medium oil and ozone resistance is required.

ADVANTAGES Good inherent flame resistance; moderate resistance to oil and gasoline; excellent adhesion to fabrics and metals; very good resistance to weather, ozone and natural aging; good resistance to abrasion and flex cracking; very good resistance to alkalis and acids.

LIMITATIONS Poor to fair resistance to aromatic and oxygenated solvents; limited ability at low temperatures.

APPLICATIONS Where mild oil resistance and weathering properties are both required (gaskets and washers, seals for doors and windows).

DUROMETER HARDNESS (SHORE A ± 5)	THICKNESS (INCHES)	AVAILABLE WIDTHS (INCHES)	TENSILE (MIN. PSI)	ULTIMATE ELONGATION (MIN. %)	TEMPERATURE RANGE	ESTIMATED WEIGHT PER LINEAR FOOT (2" X 48")
60	1 - 2	48	1000	350	-20°F to 190°F	60 lbs

*Tables display most prevalent versions of material. Unlisted durometers and manipulations to these specification can be custom manufactured.



RED RUBBER

An economical red sheet for use in low pressure applications with no oil resistant requirements. Red rubber remains the industry's general service gasket material for common applications such as water. Can be waterjet fabricated or die cut to any shape.

ADVANTAGES Excellent impact strength; very good resilience; tensile strength; abrasion resistance and flexibility at low temperatures.

LIMITATIONS Poor resistance to ozone and sunlight; very little resistance to oil, gasoline and hydrocarbon solvents.

APPLICATIONS Bulk and non-critical applications (basic gaskets and washers, skirtboards, scrapers).

DUROMETER HARDNESS (SHORE A ± 5)	THICKNESS (INCHES)	AVAILABLE WIDTHS (INCHES)	TENSILE (MIN. PSI)	ULTIMATE ELONGATION (MIN. %)	TEMPERATURE RANGE	ESTIMATED WEIGHT PER LINEAR FOOT (1/8" X 36")	SPECIFICATIONS
75	1/32 - 1/4	36, 48, 72	400	400	-20°F to 170°F	3.5 lb	ASTM D 1330 Grade 2SAE ASTM D 2000 1AA 704 Z1 (Z1 = 75 ± 5 Durometer)

*Tables display most prevalent versions of material. Unlisted durometers and manipulations to these specification can be custom manufactured.



GUM RUBBER



Excellent physical properties such as superior resilience, tensile, elongation, and abrasion resistance. Tan floating stock is produced entirely with FDA approved ingredients. It has good tear strength and is resistant to water, most salts, mild acids and other chemicals. Not suited for environments involving ozone, strong acids, animal fats, oils, greases and most hydrocarbons. Non-marking and safe to use for repeated food exposure.

ADVANTAGES Outstanding resistance; high tensile strength; superior resistance to tear and abrasion; excellent rebound elasticity (snap); good flexibility at low temperatures; excellent adhesion to fabric and metal.

LIMITATIONS Poor resistance to heat, ozone and sunlight; very little resistance to oil, gasoline and hydrocarbon solvents.

APPLICATIONS Where abrasion resistance and rebound are critical (cement sleeves, chute linings, low temperature belting, tank lining, cyclones, and concentrators).

DUROMETER HARDNESS (SHORE A ± 5)	THICKNESS (INCHES)	AVAILABLE WIDTHS (INCHES)	TENSILE (MIN. PSI)	ULTIMATE ELONGATION (MIN. %)	TEMPERATURE RANGE	ESTIMATED WEIGHT PER LINEAR FOOT (1/8" X 36")	SPECIFICATIONS
40	1/16 - 1	36, 48	3000	600	-20°F to 140°F	1.9 lb	ASTM D 2000 1AA 430 SAE J200 1 AA 430 FDA Approved Ingredients per 21 CFR 177.2600

*Tables display most prevalent versions of material. Unlisted durometers and manipulations to these specification can be custom manufactured.



For use in applications requiring higher temperature ranges, ozone, chemical and weather resistance. Can be waterjet fabricated to any shape.

ADVANTAGES Excellent resistance to heat, ozone and sunlight; very good flexibility at low temperatures; good resistance to alkalis, acids and oxygenated solvents; superior resistance to water and steam; excellent color stability.

LIMITATIONS Poor resistance to oil, gasoline and hydrocarbon solvents; adhesion to fabrics and metals is poor.

APPLICATIONS Weather-stripping for doors and windows, automotive weather-stripping, gaskets and washers around electrical equipment.

DUROMETER HARDNESS (SHORE A ± 5)	THICKNESS (INCHES)	AVAILABLE WIDTHS (INCHES)	TENSILE (MIN. PSI)	ULTIMATE ELONGATION (MIN. %)	TEMPERATURE RANGE	ESTIMATED WEIGHT PER LINEAR FOOT (1/8" X 36")	SPECIFICATIONS
50	1/16 - 1/4	36, 48	800	300	-40°F to 212°F	2.5 lb	ASTM D 2000 3BA 508 C12 SAE J200 3BA 508 C12 MIL R-3065 RS 508 C1
60	1/16 - 1/4	36, 48	800	250	-40°F to 212°F	2.6 lb	ASTM D 2000 3BA 608 C12 SAE J200 3BA 608 C12 MIL R-3065 RS 608 C1
70	1/16 - 1/4	36, 48	800	150	-40°F to 212°F	2.7 lb	ASTM D 2000 3BA 708 C12 SAE J200 3BA 708 C12 MIL R-3065 RS 708 C1

*Tables display most prevalent versions of material. Unlisted durometers and manipulations to these specification can be custom manufactured.

CLOTH INSERTED RUBBER



Where applications call for maximum conformity and deformation resistance, RAGCO offers reinforced sheet rubber in several popular combinations of fabric and compounds. Fabric reinforced rubber presents good dimensional stability under high compression loads. Custom compounding and fabrication of reinforced sheet products can be specified to match unique application requirements.

DUROMETER HARDNESS (SHORE A ± 5)	THICKNESS (INCHES)	AVAILABLE WIDTHS (INCHES)	TENSILE (MIN. PSI)	ULTIMATE ELONGATION (MIN. %)	FABRIC WEIGHT (OZ.)	FABRIC TYPE	TEMPERATURE RANGE	ESTIMATED WEIGHT PER LINEAR FOOT (1/8" X 36" IN LB.)
SBR Cotton								
65	1/16 - 1/4	36, 48, 72	1500	350	N/A	Cotton	-30°F to 170°F	2.75
SBR Polyester								
65	1/16 - 1/4	36, 48, 72	1500	350	4.0	Polyester	-30°F to 170°F	2.74
SBR Nylon								
70	1/16 - 1/4	36, 48, 72	800	250	3.4	Nylon	-20°F to 170°F	2.92
Neoprene Cotton								
70	1/16 - 1/4	36, 48, 72	1000	N/A	N/A	Cotton	-30°F to 200°F	2.41
Neoprene Polyester								
70	1/16 - 1/4	36, 48, 72	1000	N/A	4.0	Polyester	-30°F to 200°F	2.34
Neoprene Nylon								
60	1/16 - 1/4	36, 48, 72	1000	N/A	3.4	Nylon	-20°F to 170°F	2.76
Buna Nylon								
60	1/16 - 1/4	36, 48, 72	1000	400	3.4	Nylon	-20°F to 170°F	2.94

*Tables display most prevalent versions of material. Unlisted durometers and manipulations to these specification can be custom manufactured.

* RAGCO supports the autonomy of its locations to select the best products to service their markets. Subtle variations of these specification may exist. Contact your RAGCO affiliate for confirmation.



NITRILE



For use in applications requiring a rubber sheet or gasket with high resistance to petroleum based fluids.

ADVANTAGES Very good resistance to oil and gasoline; superior resistance to petroleum-based hydraulic fluids; wide range of service temperatures; good resistance to hydrocarbon solvents; very good resistance to alkalis and acids.

LIMITATIONS Inferior resistance to ozone, sunlight and natural aging; poor resistance to oxygenated solvents.

APPLICATIONS Where oil resistance is the main concern (machinery gaskets, around oil and gas handling equipment, heat and oil resistant belting).

DUROMETER HARDNESS (SHORE A ± 5)	THICKNESS (INCHES)	AVAILABLE WIDTHS (INCHES)	TENSILE (MIN. PSI)	ULTIMATE ELONGATION (MIN. %)	TEMPERATURE RANGE	ESTIMATED WEIGHT PER LINEAR FOOT (1/8" X 36")	SPECIFICATIONS
40	1/16 - 1	36, 48	800	350	-20°F to 170°F	2.5 lb	ASTM D 2000 1BF 408 Z1, SAE J200 1BF 408 Z1 (Z1 = Meets basic requirements for BF materials. Physical properties are as listed.)
50	1/32 - 1	36, 48	800	300	-20°F to 170°F	2.6 lb	ASTM D 2000 1BF 508 Z1, SAE J200 1BF 508 Z1 (Z1 = Meets basic requirements for BF materials. Physical properties are as listed.)
60	1/32 - 1	36, 48	900	200	-20°F to 170°F	2.7 lb	ASTM D 2000 1BF 609, SAE J200 1BF 609
70	1/32 - 1	36, 48	1000	200	-20°F to 170°F	2.7 lb	ASTM D 2000 1BF 710, SAE J200 1BF 710
80	1/32 - 1	36, 48	1000	100	-20°F to 170°F	2.8 lb	ASTM D 2000 1BF 810, SAE J200 1BF 810

*Tables display most prevalent versions of material. Unlisted durometers and manipulations to these specification can be custom manufactured.



WHITE FDA NITRILE



A sheet specially formulated for its whiteness, used in food, pharmaceutical, and cosmetic processing. Made from FDA-approved ingredients per 21CFR 177.2600, it is non-marking, non-allergenic, and safe to use for repeated food exposure. It has good oil and abrasion resistance and handles oily and greasy food products well. **White in color.**

ADVANTAGES Very good resistance to oil and gasoline; superior resistance to petroleum-based hydraulic fluids; wide range of service temperatures; good resistance to hydrocarbon solvents; very good resistance to alkalis and acids.

LIMITATIONS Inferior resistance to ozone, sunlight and natural aging; poor resistance to oxygenated solvents.

APPLICATIONS Where oil resistance is the main concern (machinery gaskets, around oil and gas handling equipment, white food grade, heat and oil resistant belting).

DUROMETER HARDNESS (SHORE A ± 5)	THICKNESS (INCHES)	AVAILABLE WIDTHS (INCHES)	TENSILE (MIN. PSI)	ULTIMATE ELONGATION (MIN. %)	TEMPERATURE RANGE	ESTIMATED WEIGHT PER LINEAR FOOT (1/8" X 36")	SPECIFICATIONS
60	1/32 - 1/4	36, 48	1000	350	-25°F to 180°F	2.8 lb	ASTM D 2000 1BG 610, FDA-approved ingredients per 21CFR 177.2600

*Tables display most prevalent versions of material. Unlisted durometers and manipulations to these specification can be custom manufactured.



A premium grade fluoro-elastomer sheet for the most demanding applications. Excellent heat and chemical resistance, but not suitable for flex fuels containing high levels of alcohol or MTBE.

DUROMETER HARDNESS (SHORE A ± 5)	THICKNESS (INCHES)	AVAILABLE WIDTHS (INCHES)	TENSILE (MIN. PSI)	ULTIMATE ELONGATION (MIN. %)	COLOR	TEMPERATURE RANGE	ESTIMATED WEIGHT PER LINEAR FOOT (1/8" X 36")
75	1/32 - 1	36, 48	1000	175	Black	-20°F to 400°F	3.76 lb

*Tables display most prevalent versions of material. Unlisted durometers and manipulations to these specification can be custom manufactured.



With resistance to most chemicals, temperature extremes, ultraviolet light, and oil, Hypalon® chlorosulfonated polyethylene is used in a wide range of industrial and automotive applications where high performance is critical.

ADVANTAGES Flame resistance, Excellent color stability, Weather and abrasion resistance, Low moisture absorption, Good dielectric qualities, High abrasion resistance

DUROMETER HARDNESS (SHORE A ± 5)	THICKNESS (INCHES)	AVAILABLE WIDTHS (INCHES)	TENSILE (MIN. PSI)	ULTIMATE ELONGATION (MIN. %)	TEMPERATURE RANGE	ESTIMATED WEIGHT PER LINEAR FOOT (1/8" X 36")
60	1/16 - 3/8	36, 48	900	500	-62°F to 210°F	2.9 lb

*Tables display most prevalent versions of material. Unlisted durometers and manipulations to these specification can be custom manufactured.

SILICONE

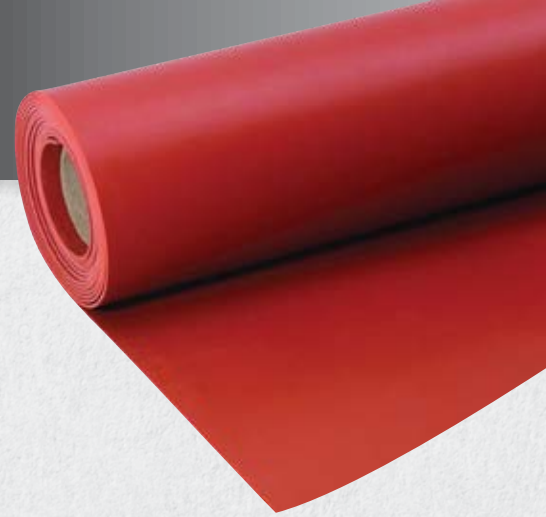

Silicone sheet is designed to be used in applications where extreme high and low temperature resistance is needed. This material also provides excellent UV and ozone resistance, is non-toxic, chemically inert and fungus resistant.

DUROMETER HARDNESS (SHORE A ± 5)	THICKNESS (INCHES)	AVAILABLE WIDTHS (INCHES)	TENSILE (MIN. PSI)	ULTIMATE ELONGATION (MIN. %)	TEMPERATURE RANGE	ESTIMATED WEIGHT PER LINEAR FOOT (1/8" X 36")	FEATURES
60	1/16 - 1/4	36, 48	500	200	-65°F to 400°F	2.59 lb	High & Low Temperature Resistance, Excellent Weathering Resistance

*Tables display most prevalent versions of material. Unlisted durometers and manipulations to these specification can be custom manufactured.

BUTYL



Butyl rubber has exceptionally low gas and moisture permeability and outstanding resistance to heat aging, weather, ozone, chemical attack, flexing, abrasion and tearing. It is resistant to phosphate ester based hydraulic fluids, and has excellent electrical insulation performance. Butyl is not recommended for use when in contact with petroleum oils and fluids.

DUROMETER HARDNESS (SHORE A ± 5)	THICKNESS (INCHES)	AVAILABLE WIDTHS (INCHES)	TENSILE (MIN. PSI)	ULTIMATE ELONGATION (MIN. %)	TEMPERATURE RANGE	ESTIMATED WEIGHT PER LINEAR FOOT (1/8" X 36")
60	1/16 - 1/4	36, 48	800	350	-30°F to 230°F	3.1 lb

*Tables display most prevalent versions of material. Unlisted durometers and manipulations to these specification can be custom manufactured.

SPONGE RUBBER

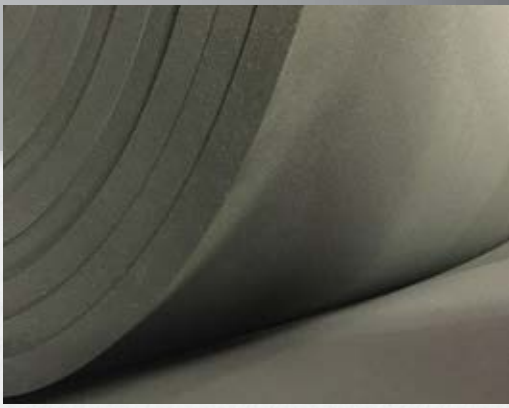

Available plain or with PSA backing close cell sponge rubber is an economical seal with excellent compression. This material can be used to absorb shocks, cushion, deaden sound and seal against, air moisture and light and dust penetration. The blend of Neoprene and EPDM makes this material moderately resistant to oil and ozone. Meets a variety of industry specifications. Pre-split weather stripping also available.

SCE41B TYPICAL PROPERTIES (Soft Density)

PHYSICAL PROPERTY	TEST METHOD	UNIT OF MEASURE	RESULT
COMPRESSION DEFLECTION 25%	ASTM D1056	psi	2 - 5
		kPa	13.8 - 34.4
DENSITY	ASTM D1056	pcf	4 - 8
		g/cm ³	0.64 - 0.128
COMPRESSION SET (Max)	ASTM D1056	%	40
WATER ABSORPTION (Max)	ASTM D1056	%	10
TENSILE STRENGTH (Typical)	ASTM D412 (DIE A)	psi	75
		kPa	517
ELONGATION (Typical)	ASTM D412 (DIE A)	%	125
TEAR STRENGTH (Typical)	ASTM D624 (DIE C)	lb / in	9.6
		kN / m	1.7
CD CHANGE AFTER OVEN AGING	ASTM D1056	%	±30
RESILIENCE (Typical)	ASTM D2632	%	35
COLOR	N/A	N/A	Black

SPECIFICATIONS

ASTM D1056-67 — SCE41
 ASTM D1056-78 — RE41
 ASTM D1056-07 — 2A1
 ASTM D1056 Suffix's — A1, C1, F2, M
 ASTM D6576-07 — Type II A, B, C Soft
 MIL-R-6130C — II-A Soft
 MIL-C-3133C MIL STD 670 B — SCE3
 UL48/ UL50 / UL50E / UL157 / UL508 — Listed

FLAMMABILITY SPECIFICATIONS

UL94 HF-1 — LISTED¹
 FMVSS-302 — Pass(.098" or Thicker)
¹ Contact customer service for thickness data.

ADDITIONAL INFORMATION

Service Temperature — 40°F to 200°F
 High Intermittent Temperature — 250°F
 Thermal Conductivity— .38 Btu-in/hr-Ft²-°F

*Tables display most prevalent versions of material. Unlisted durometers and manipulations to these specification can be custom manufactured.

POLYMER NEOPRENE / EPDM / SBR

SCE42B TYPICAL PROPERTIES (Medium Density)

PHYSICAL PROPERTY	TEST METHOD	UNIT OF MEASURE	RESULT
COMPRESSION DEFLECTION 25%	ASTM D1056	psi	5 - 9
		kPa	34.5 - 62
DENSITY	ASTM D1056	pcf	4 - 8
		g/cm ³	0.64 - 0.128
COMPRESSION SET (Max)	ASTM D1056	%	40
WATER ABSORPTION (Max)	ASTM D1056	%	10
TENSILE STRENGTH (Typical)	ASTM D412 (DIE A)	psi	75
		kPa	517
ELONGATION (Typical)	ASTM D412 (DIE A)	%	125
TEAR STRENGTH (Typical)	ASTM D624 (DIE C)	ib / in	9.6
		kN / m	1.7
CD CHANGE AFTER OVEN AGING	ASTM D1056	%	±30
RESILIENCE (Typical)	ASTM D2632	%	35
COLOR	N/A	N/A	Black

SPECIFICATIONS

ASTM D1056-67 — SCE41
 ASTM D1056-78 — RE41
 ASTM D1056-07 — 2A1
 ASTM D1056 Suffix's — A1, C1, F2, M
 ASTM D6576-07 — Type II A, B, C Soft
 MIL-R-6130C — II-A Soft
 MIL-C-3133C MIL STD 670 B — SCE3
 UL48/ UL50 / UL50E / UL157 / UL508 — Listed

FLAMMABILITY SPECIFICATIONS

UL94 HF-1 — LISTED¹
 FMVSS-302 — Pass(.098" or Thicker)
¹ Contact customer service for thickness data.

ADDITIONAL INFORMATION

Service Temperature — 40°F to 200°F
 High Intermittent Temperature — 250°F
 Thermal Conductivity— .38 Btu-in/hr-Ft²-°F

*Tables display most prevalent versions of material. Unlisted durometers and manipulations to these specification can be custom manufactured.

POLYMER NEOPRENE / EPDM / SBR

* RAGCO supports the autonomy of its locations to select the best products to service their markets. Subtle variations of these specification may exist. Contact your RAGCO affiliate for confirmation.

SPONGE RUBBER continued

SCE43B TYPICAL PROPERTIES (Hard Density)

PHYSICAL PROPERTY	TEST METHOD	UNIT OF MEASURE	RESULT
COMPRESSION DEFLECTION 25%	ASTM D1056	psi	9 - 13
		kPa	62 - 89.6
DENSITY	ASTM D1056	pcf	7 - 11
		g/cm ³	0.112 - 0.176
COMPRESSION SET (Max)	ASTM D1056	%	30
WATER ABSORPTION (Max)	ASTM D1056	%	10
TENSILE STRENGTH (Typical)	ASTM D412 (DIE A)	psi	100
		kPa	690
ELONGATION (Typical)	ASTM D412 (DIE A)	%	125
TEAR STRENGTH (Typical)	ASTM D624 (DIE C)	lb / in	15
		kN / m	2.6
CD CHANGE AFTER OVEN AGING	ASTM D1056	%	±30
RESILIENCE (Typical)	ASTM D2632	%	20
COLOR	N/A	N/A	Black

SPECIFICATIONS

ASTM D1056-67 — SCE43
 ASTM D1056-78 — RE43
 ASTM D1056-07 — 2A3
 ASTM D1056 Suffix's — A1, C1, F1, M
 ASTM D6576-07 — Type II A, B, Medium
 MIL-R-6130C — II-A Medium
 MIL-C-3133C MIL STD 670 B — SCE11
 UL48/ UL50 / UL50E / UL157 / UL508 — Listed

FLAMMABILITY SPECIFICATIONS

UL94 HF-1 — LISTED¹
 FMVSS-302 — Pass(.098" or Thicker)
¹ Contact customer service for thickness data.

ADDITIONAL INFORMATION

Service Temperature — 40°F to 200°F
 High Intermittent Temperature — 250°F
 Thermal Conductivity— .38 Btu-in/hr-Ft²-°F

*Tables display most prevalent versions of material. Unlisted durometers and manipulations to these specification can be custom manufactured.

POLYMER NEOPRENE / EPDM / SBR



CORK RUBBER

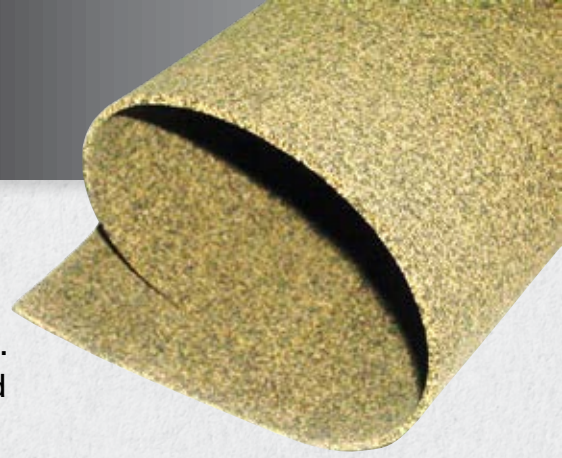

Cork Rubber material is a mixture of first grade granulated cork and a synthetic rubber polymer. This gives the product the high resilience of rubber and the compressibility of cork. It is manufactured by conjoining the cork, glycerin-glue, and a rubber binder under heat and pressure.

The material is typically 70% cork to 30% rubber binder. The rubber is added to provide the ability to seal and provide chemical resistance while helping to resist fungus, acid and weather conditions. It is an excellent material for gaskets and other industrial sealing applications. Cork rubber material is available in a wide variety of rubber options including: EPDM, Natural Rubber, Neoprene®, Hypalon®, Silicone, Viton®, Nitrile (Buna-N) to best suit the chemical resistance requirement of the gasket. The choice of the best blend of cork and rubber with the proper density will ensure that the finished cork gasket or cork product will last for many years in your application.

ADVANTAGES Excellent compressibility & flexibility, wide range of fluid compatibility, good resistance to oil, solvents, and fuels, moderately resistant to fungus, acid, ozone, and weather conditions, resistant to fluid infiltration, reduces levels of transmitted vibration, acoustic insulation, good for low bolt load application, anti-slip and impact-resistant, shock absorber.

***Specifications omitted due to the wide variety of options (rubber compounds and densities)**

Typical cork rubber applications include: gaskets, bumpers, spacers, stripping, protective pads, anti-vibration, electrical transformers, electrical switchgear, sumps, and crank case covers.

Cork rubber gaskets are used in a wide range of industries including: marine, defense, automotive, railroad, aviation, agricultural, tractor, ship, transformer, petroleum, compressor and electrical equipment.

Cork materials are available with or without pressure sensitive adhesive (PSA) backing.

AASHTO BEARING PAD



Neoprene Bearing Pads provide a uniform transfer of load from beam to substructure. They permit beam rotation at the bearing point due to deflection or misalignment. They absorb vibration and prevent sound transfer, while reducing the destructive action of vibration between

movable and stationary structural members. They also provide for movement caused by normal expansion and contraction. Neoprene Bearing Pads are used extensively in bridge structures and pre-stressed and precast concrete buildings. Also used in industrial machinery and heavy equipment applications.

DUROMETER HARDNESS (SHORE A ± 5)	SPECIFICATIONS	THICKNESS (INCHES)	AVAILABLE WIDTHS (INCHES)	TENSILE (MIN. PSI)	ULTIMATE ELONGATION (MIN. %)	TEMPERATURE RANGE	ESTIMATED WEIGHT PER LINEAR FOOT (1/8" X 36")
50	AASHTO Grade 3 Neoprene	1/8 - 1/2	36, 48	2550	440	-40°F to 220°F	2.54 lb
60	AASHTO Grade 3 Neoprene	1/8 - 1/2	36, 48	3000	380	-40°F to 220°F	2.56 lb
70	AASHTO Grade 2 Neoprene	1/8 - 1/2	36, 48	3500	320	-40°F to 220°F	2.6 lb

ASTM TEST METHOD	PROPERTY	DUROMETER HARDNESS 50 (SHORE A ± 5) 50-E-0052	DUROMETER HARDNESS 60 (SHORE A ± 5) 60-E-0054	DUROMETER HARDNESS 70 (SHORE A ± 5) 70-E-0056
ASTM D 573 Heat Resistance	Change in durometer hardness, max. points	15	15	15
	Change in tensile, max. %	-15	-15	-15
	Change in ultimate elongation, max. %	-40	-40	-40
ASTM D 395 Compression Set	22 hours at 212°F, max. %	35	35	35
ASTM D 1149 Ozone	100 pphm ozone in air by volume, 20% strain, 100°F ± 2°F 100 hours mounting procedure D518, Procedure A	No Cracks	No Cracks	No Cracks
ASTM D 746 Low Temperature Brittleness	Grade 3 at -40°F	No Failure	No Failure	No Failure
ASTM D 1043 Instantaneous Thermal Stiffening	Grade 3 at -40°F	Stiffness at test time shall not exceed 4 times the stiffness measured at 73°F		
Low Temperature Crystallization Quad Shear Test	Grade 3 14 days at -15°F	Stiffness at test time and temperature shall not exceed 4 times the stiffness measured at 73°F with no time delay		

*Tables display most prevalent versions of material. Unlisted durometers and manipulations to these specification can be custom manufactured.



SKIRTBOARD RUBBER

Abrasion resistant, flexible, and excellent for use as conveyor skirting, chute lining, snow plow blades, and more.

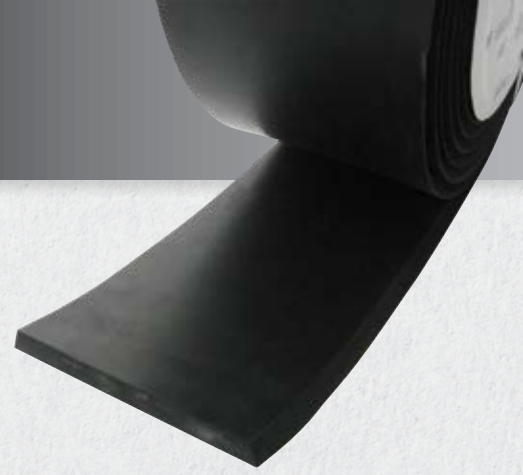

ADVANTAGES Excellent impact strength; very good resilience; tensile strength; abrasion resistance and flexibility at low temperatures

LIMITATIONS Poor resistance to ozone and sunlight; very little resistance to oil, gasoline and hydrocarbon solvents.

APPLICATIONS Bulk and non-critical applications (basic gaskets and washers, skirtboards, scrapers).

DUROMETER HARDNESS (SHORE A ± 5)	THICKNESS (INCHES)	AVAILABLE WIDTHS (INCHES)	TENSILE (MIN. PSI)	ULTIMATE ELONGATION (MIN. %)	TEMPERATURE RANGE	ESTIMATED WEIGHT PER LINEAR FOOT (1/4" X 48")
60	1/4 - 2	Any	1000	300	-20°F to 180°F	7.8 lb

*Tables display most prevalent versions of material. Unlisted durometers and manipulations to these specification can be custom manufactured.

GREEN GENERAL PURPOSE GASKET SHEET

Excellent gasket material with good chemical and petroleum resistance. Excellent sealability in oil, gasoline, mild chemical, water, and other fluid applications. See our commercial flange gasket chart for information on standard gasket sizes.

TENSILE STRENGTH	2400 PSI	MAX P x T	1/32", 1/16" - 350,000 (°F x PSIG) 1/8" - 250,000 (°F x PSIG)
MAX TEMPERATURE	430°F CONTINUOUS 720°F MAXIMUM	DENSITY	100 lbs/ft ³
MAX PRESSURE	1000 PSI	WEIGHT (SF, 1/8")	1.12 lbs
COLOR	Branded/Unbranded Green/Blue	ASTM-D-F104 CALL OUT	F711111B4E21M5

INDUSTRY CROSSOVER: 3000, C4401

COMPRESSED GASKET SHEET with SBR BINDER

Constructed from aramid fibers and an SBR binder this material serves in water, inert gases, and saturated steam applications (saturated steam under 150psi). Provides excellent sealability and drastically lowered emission levels.

TENSILE STRENGTH	2250 PSI	MAX P x T	1/32", 1/16" - 350,000 (°F x PSIG) 1/8" - 250,000 (°F x PSIG)
MAX TEMPERATURE	400°F CONTINUOUS 700°F MAXIMUM	DENSITY	1.6 g/cm ²
MAX PRESSURE	1200 PSI	WEIGHT (SF, 1/8")	0.988 lbs

INDUSTRY CROSSOVER: 3200, 3400, C6400



COMPRESSED GASKET SHEET

with NEOPRENE BINDER

Constructed from aramid fibers and a neoprene binder this sheet serves in water, refrigerant, oil, fuel, and saturated steam applications (saturated steam under 150psi). Provides excellent sealability and drastically lowered emission levels.

TENSILE STRENGTH	1500 PSI	MAX P x T	1/32", 1/16" - 400,000 (°F x PSIG) 1/8" - 275,000 (°F x PSIG)
MAX TEMPERATURE	550°F CONTINUOUS 800°F MAXIMUM	DENSITY	110 lbs/ft ³
MAX PRESSURE	1200 PSI	WEIGHT (SF, 1/8")	1.040 lbs

INDUSTRY CROSSOVER: 3300, C5400

COMPRESSED GASKET SHEET

with EPDM BINDER

Constructed from aramid fibers and an EPDM binder this material serves in water, inert gases, and saturated steam applications (saturated steam under 150psi). Provides excellent sealability and drastically lowered emission levels.

TENSILE STRENGTH	2500 PSI	MAX P x T	1/32", 1/16" - 350,000 (°F x PSIG) 1/8" - 250,000 (°F x PSIG)
MAX TEMPERATURE	400°F CONTINUOUS 700°F MAXIMUM	DENSITY	110 lbs/ft ³
MAX PRESSURE	1200 PSI	WEIGHT (SF, 1/8")	0.972 lbs

INDUSTRY CROSSOVER: 3700, C7400

* RAGCO supports the autonomy of its locations to select the best products to service their markets. Subtle variations of these specification may exist. Contact your RAGCO affiliate for confirmation.

INORGANIC FIBER GASKET SHEET

Constructed with inorganic fibers with a nitrile binder. Reduced creep relaxation and improved torque retention provide optimal sealing. Most inorganic fiber gasket sheets are ABS Fire Safe Type approved.

TENSILE STRENGTH	1500 PSI	MAX P x T	1/32", 1/16" - 400,000 (°F x PSIG) 1/8" - 275,000 (°F x PSIG)
MAX TEMPERATURE	550°F CONTINUOUS 800°F MAXIMUM	DENSITY	110 lbs/ft ³
MAX PRESSURE	1200 PSI	WEIGHT (SF, 1/8")	1.040 lbs

INDUSTRY CROSSOVER: IFG-5500, C4433

OIL PAPER / VEGETABLE FIBER

Premium grade vegetable fiber sheet packing, efficiently saturated with a glue-glycerin impregnant rendered insoluble by means of a tanning agent to create a strong, flexible, all-proof packing.

COLOR	TAN/BROWN	MAX TEMPERATURE	250°F
PRESSURE	1000 PSI	TENSILE STRENGTH	2000 PSI
COMPRESSABILITY	25% - 40%		



HIGH-TEMPERATURE COMPRESSED SHEET

These high-temperature gasket materials excel in the harshest conditions- intense heat, high pressure, saturated steam and hot oils. The complex engineering process involves laboratory tests for fire safety. They maintain effective seal during pressure and temperature fluctuations. Superior torque retention lowers leakage rates and reduces maintenance time.

GRAPHITE COMPRESSED with NITRILE BINDER

TENSILE STRENGTH	1800 PSI	MAX P x T	1/32", 1/16" - 700,000 (°F x PSIG) 1/8" - 350,000 (°F x PSIG)
MAX TEMPERATURE	650°F CONTINUOUS 1000°F MAXIMUM	DENSITY	110 lbs/ft ³
MAX PRESSURE	2000 PSI	WEIGHT (SF, 1/8")	1.190 lbs

INDUSTRY CROSSOVER: G-9900

CARBON FIBER COMPRESSED with NITRILE BINDER

TENSILE STRENGTH	1500 PSI	MAX P x T	1/32", 1/16" - 350,000 (°F x PSIG) 1/8" - 250,000 (°F x PSIG)
MAX TEMPERATURE	650°F CONTINUOUS 900°F MAXIMUM	DENSITY	105 lbs/ft ³
MAX PRESSURE	2000 PSI	WEIGHT (SF, 1/8")	1.11 lbs

INDUSTRY CROSSOVER: 9850, C4500

GRAPHITE GASKET MATERIALS

Graphite Gasket Products are flat gasketing materials composed of pure, exfoliated flake material. These materials excel in extreme conditions, withstand high temperatures, high pressures, and aggressive chemicals, and are proven fire-safe. Graphite provides a reliable seal as it seals easily under moderate bolt load, offers superior torque retention, retains dimensional stability in high temperatures and seals tightly even during pressure fluctuations. Flexible graphite is manufactured in such a manner that no organic or inorganic binders and fillers are introduced—the end product is essentially graphite with outstanding physical properties. The insertion of wire mesh, stainless steel foil, and tanged metal inserts increase strength and ease of handling

BENEFITS

EXCELLENT RESISTANCE

- Pure exfoliated graphite flake material excels in extreme conditions, withstanding heat, pressure, and aggressive chemicals
- Proven fire-safe

RELIABLE SEAL

- Seals easily under moderate bolt load, offers superior torque retention
- Retains dimensional stability in high temperatures; seals tightly even during pressure fluctuations

HOMOGENEOUS GRAPHITE SHEET

MIN TEMPERATURE	-400°F	MAX PRESSURE	1200 PSI
MAX TEMPERATURE	850°F	MAX P x T	1/16" - 700,000 (°F x PSIG) 1/8" - 350,000 (°F x PSIG)

INDUSTRY CROSSOVER: 3123, 3125, HL

316SS WIRE MESH INSERTED GRAPHITE SHEET

MIN TEMPERATURE	-400°F	MAX PRESSURE	2000 PSI
MAX TEMPERATURE	850°F	MAX P x T	1/16" - 700,000 (°F x PSIG) 1/8" - 350,000 (°F x PSIG)

INDUSTRY CROSSOVER: 3124, 3126



COMPRESSED
GASKET SHEET

* RAGCO supports the autonomy of its locations to select the best products to service their markets. Subtle variations of these specification may exist. Contact your RAGCO affiliate for confirmation.

316SS FOIL INSERTED GRAPHITE SHEET

MIN TEMPERATURE	-400°F	MAX PRESSURE	2000 PSI
MAX TEMPERATURE	850°F	MAX P x T	1/16" - 700,000 (°F x PSIG) 1/8" - 350,000 (°F x PSIG)

INDUSTRY CROSSOVER: 3125SS, SLS

316SS TANG INSERTED GRAPHITE SHEET

MIN TEMPERATURE	-400°F	MAX PRESSURE	2000 PSI
MAX TEMPERATURE	850°F	MAX P x T	1/16" - 700,000 (°F x PSIG) 1/8" - 350,000 (°F x PSIG)

INDUSTRY CROSSOVER: 3125TC, PSM

PTFE GASKET PRODUCTS

PTFE Gasket Products are flat PTFE gasketing materials. These high-performance PTFE materials are manufactured using a process that imparts unique physical properties, which are not obtainable through conventional manufacturing methods.

Designed for severe chemical service, color-coded for easy identification, superior sealability, which helps reduce process and media loss as well as fugitive emissions, reduced creep and cold flow characteristics, and patented thermal bonding process to fabricate virtually any size gasket. The process reorients the PTFE and fillers in such a way to increase the material's tensile properties and decrease the creep relaxation problems that usually plague PTFE products. In addition, the mixing process creates a homogenous material with consistent, superior physical properties that, unlike inexpensive skived PTFE sheet materials, do not fluctuate from one side of the sheet to another.

PTFE GASKET PRODUCTS

- PTFE Gasketing with Aluminosilicate Microspheres
- NSF 61 Approved/Oxygen Service PTFE Gasketing with Aluminosilicate Microspheres
- PTFE Gasketing with Barium Sulfate Filler
- PTFE with Graphite Filler
- Microcellular PTFE Gasketing



PTFE GASKETING with ALUMINOSILICATE MICROSPHERES

BENEFITS

TIGHTER SEAL

- Improved performance over conventional PTFE
- Reduced product loss and emissions

REDUCED CREEP RELAXATION

- Unique manufacturing process minimizes cold flow problems typical of skived and expanded PTFE sheets
- Excellent bolt torque retention

CHEMICAL RESISTANCE

- Withstands a wide range of chemicals for extended service life in a wide variety of applications

COST SAVINGS

- Cuts operational costs through reduced: Fluid loss, Energy consumption, Maintenance costs, Inventory costs, Waste

LARGEST SHEET SIZES

- Offers some of the largest sheet sizes in the industry
- Improved material utilization reduces waste

BRANDING AND COLOR CODING

- Easy identification of superior products
- Reduces misapplication and use of unauthorized, inferior substitutes

MEDIA

- Moderate concentrations of acids and some caustics
- Hydrocarbons
- Solvents
- Water
- Refrigerants
- Cryogenics, hydrogen peroxide (For oxygen service, specify "Style 3505 for oxygen service.")

MIN TEMPERATURE	-450°F	MAX PRESSURE	800 PSI
MAX TEMPERATURE	500°F	MAX P x T	1/16" - 350,000 (°F x PSIG) 1/8" - 250,000 (°F x PSIG)

INDUSTRY CROSSOVER: 3504, TC1003

NSF 61 APPROVED/OXYGEN SERVICE PTFE GASKETING with ALUMINOSILICATE MICROSPHERES

BENEFITS TIGHTER SEAL

- Improved performance over conventional PTFE
- Reduced product loss and emissions

REDUCED CREEP RELAXATION

- Unique manufacturing process minimizes cold flow problems typical of skived and expanded PTFE sheets
- Excellent bolt torque retention

CHEMICAL RESISTANCE

- Withstands a wide range of chemicals for extended service life in a wide variety of applications

COST SAVINGS

- Cuts operational costs through reduced: Fluid loss, Energy consumption, Maintenance costs, Inventory costs, Waste

LARGEST SHEET SIZES

- Offers some of the largest sheet sizes in the industry
- Improved material utilization reduces waste

BRANDING AND COLOR CODING

- Easy identification of superior products
- Reduces misapplication and use of unauthorized, inferior substitutes

MEDIA

- Potable drinking water
- Hydrocarbons
- Solvents
- Moderate concentrations of acids and some caustics
- Refrigerants
- Cryogenics, hydrogen peroxide

MIN TEMPERATURE	-450°F	MAX PRESSURE	800 PSI
MAX TEMPERATURE	500°F	MAX P x T	1/16" - 350,000 (°F x PSIG) 1/8" - 250,000 (°F x PSIG)

INDUSTRY CROSSOVER: 3505



COMPRESSED
GASKET SHEET

* RAGCO supports the autonomy of its locations to select the best products to service their markets. Subtle variations of these specification may exist. Contact your RAGCO affiliate for confirmation.

PTFE GASKETING with BARIUM SULFATE FILLER

BENEFITS

TIGHTER SEAL

- Improved performance over conventional PTFE
- Reduced product loss and emissions

REDUCED CREEP RELAXATION

- Unique manufacturing process minimizes cold flow problems typical of skived and expanded PTFE sheets
- Excellent bolt torque retention

CHEMICAL RESISTANCE

- Withstands a wide range of chemicals for extended service life in a wide variety of applications

COST SAVINGS

- Cuts operational costs through reduced: Fluid loss, Energy consumption, Maintenance costs, Inventory costs, Waste

LARGEST SHEET SIZES

- Offers some of the largest sheet sizes in the industry
- Improved material utilization reduces waste

BRANDING AND COLOR CODING

- Easy identification of superior products
- Reduces misapplication and use of unauthorized, inferior substitutes

MEDIA

- Strong caustics
- Moderate acids
- Chlorine
- Gases
- Water
- Steam
- Hydrocarbons
- Cryogenics and aluminum fluoride (For oxygen service, specify "Style 3503 for oxygen service.")

MIN TEMPERATURE	-450°F	MAX PRESSURE	1200 PSI
MAX TEMPERATURE	500°F	MAX P x T	1/16" - 350,000 (°F x PSIG) 1/8" - 250,000 (°F x PSIG)

INDUSTRY CROSSOVER: 3510, TC1005

PTFE with GRAPHITE FILLER

BENEFITS TIGHTER SEAL

- Graphite-filled PTFE offers extremely low void content for minimal emissions
- Delivers long service against volatile hazardous pollutants (VHAP and VOC)
- Withstands high concentrations of hydrofluoric acids and other glass-dissolving media

MEDIA

- Monomer service
- Cryogenics
- Highly concentrated hydrofluoric acid
- Volatile hazardous air pollutants (VHAP)

MIN TEMPERATURE	-450°F	MAX PRESSURE	1200 PSI
MAX TEMPERATURE	500°F	MAX P x T	1/16" - 350,000 (°F x PSIG) 1/8" - 250,000 (°F x PSIG)

INDUSTRY CROSSOVER: 3530

MICROCELLULAR PTFE GASKETING

BENEFITS

TIGHTER SEAL

- Highly compressible PTFE seals under low bolt load- suitable for many non-metallic flanges*
- Compressible material conforms to surface irregularities, especially on warped, pitted or scratched flanges
- Reduced cold flow and creep normally associated with conventional PTFE gaskets

EXCELLENT CHEMICAL COMPATIBILITY

- Pure PTFE withstands a wide range of chemicals

EASY TO CUT AND INSTALL

- Soft PTFE can be cut easily from larger sheets, reducing inventory costs and expensive downtime

MEDIA

- Strong caustics
- Strong acids
- Hydrocarbons
- Chlorine
- Cryogenics
- Glasslined equipment

*For flat face flanges, a minimum compressive stress of 1,500psi is recommended on the contacted gasket area for 150psig liquid service. Consult with the flange manufacturer to confirm that adequate compressive stress is available.

MIN TEMPERATURE	-450°F	MAX PRESSURE	1200 PSI
MAX TEMPERATURE	500°F	MAX P x T	1/16" - 350,000 (°F x PSIG) 1/8" - 250,000 (°F x PSIG)

INDUSTRY CROSSOVER: 3540

PTFE SHEET (Teflon®)

PTFE (also known by the trade name Teflon®) has a very high melting point, and is capable of continued service at 500F (260 C). PTFE products are used as gasket and packing materials in chemical processing equipment; as electrical insulation for maximum reliability; and in bearings, seals, piston rings and other mechanical applications -especially those requiring anti-stick characteristics. PTFE has excellent thermal and electrical insulation properties, and it has a low coefficient of friction. PTFE is known for its non-stick properties. Materials may stick to it but can be peeled off or rubbed off. Available in virgin or mechanical grade.

COLOR	WHITE	TENSILE ELONGATION AT BREAK	300%
DUROMETER HARDNESS SHORE D	50	DENSITY	0.078 lbs/ft ³
TENSILE STRENGTH	3900 PSI	COMPRESSIVE STRENGTH	3500 PSI
WATER ABSORPTION (24 HOURS)	0.05%	DIELECTRIC STRENGTH WEIGHT (1/8" PER SF)	285 v/mil 1.5 lbs

PTFE JOINT SEALANT (Sealex®)

Sealex joint sealant can be used wherever reliable gasketing is required.

- Fume ducts
- Concrete lids
- Glass joints
- Heat exchangers
- Fiberglass reinforced plastic vessels
- Pump or compressor housing flanges
- Steam vessel flanges
- Ceramic joints
- Water systems
- Valves and piping



Sealex® joint sealant, specially processed, 100% pure PTFE on a roll, provides soft, highly compressible gasketing for longer life and trouble-free sealing. Its form-in-place versatility also cuts maintenance and storage costs. The high compressibility of Sealex® enables it to effectively fill flange imperfections for a tight, leak-free seal. Under pressure, it provides a very wide, thin ribbon-like joint sealant. Unlike conventional PTFE which is prone to cold flow, Sealex® has good creep resistance and bolt torque retention properties. Sealex joint sealant does not support bacterial growth or cause product contamination and is FDA compliant. It has virtually no shelf-life concerns since PTFE is unaffected by normal environmental conditions.

Sealex has excellent resistance properties to chemical attack. It is ideal for most chemical services at temperatures to 500°F (260°C) and pressure to 2,000 psi (138 bar). It is also suitable for cryogenic use to -321°F (-196°C).

The sealant is available in roll form which helps reduce storage space, and is available in a wide variety of thicknesses and lengths.

EASY TO USE SEALEX

Just follow the simple installation instructions.

Select the size Sealex: Use a size with nominal width of between 1/3 and 1/2 of the effective flange sealing width.

1. Make sure that the sealing flanges are clean.
2. Cut off a length of Sealex just a little longer than the actual circumference of the perimeter of the seal.
3. Peel off the adhesive protection strip, and press the Sealex into position. Cross the free ends of the Sealex adjacent to the bolt hole.
4. Bolt up the mating surfaces using the recommended clamping force and bolt tightening patterns.

* RAGCO supports the autonomy of its locations to select the best products to service their markets. Subtle variations of these specification may exist. Contact your RAGCO affiliate for confirmation.

PTFE JOINT SEALANT (Sealex®) continued

PRESSURE & TEMPERATURE GRAPHS

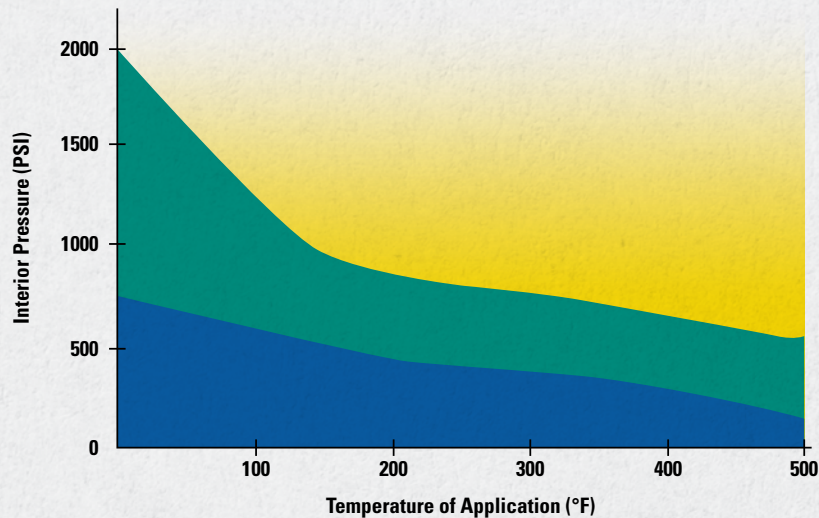

SEALEX® Pressure/Temperature Curves

The pressure/temperature graphs shown are the most current method of determining the suitability of a gasket material in a known environment. Use the pressure and temperature graphs to select the most suitable material for your application.

1. In area one, the gasket material is suitable using common installation practices subject to chemical compatibility.
2. In area two, appropriate measures are necessary for installation of the gasket to ensure maximum performance. Please call or refer to the KLINGER® expert software system for assistance.
3. In area three, do not install gaskets in these applications without first referring to the KLINGER® expert software system or contacting Thermoseal Inc.'s technical support service

These graphs were developed from testing Klinger materials. Do not use them for competitors' materials since non-asbestos gasketing materials do not have service equivalents.

USE The limitations of use, as shown in the graphs, are for guidance only, and are based on 1/16" thick material. The limitations of use decrease significantly as gasket thickness increases. Do not use a thicker gasket material or "double gaskets" to solve a gasket problem without first consulting the manufacturer. The ability of a gasket material to make and maintain a seal depends not only on the quality of the gasket material, but also on medium being sealed, the flange design, the amount of pressure applied to the gasket by the bolts and how the gasket is assembled into the flanges and tightened. Thermoseal engineers can advise on gasket selection and installation based on specified operating conditions.

CONTACT If you are in any doubt, fax us at 937.498.4911 or phone us at 937.498.2222.



COMMERCIAL FLANGE DIMENSIONS

RING GASKETS FOR 125/150# ANSI PIPE FLANGES (INCHES)

NOMINAL PIPE SIZE	ID	OD
1/2	27/32	1-7/8
3/4	1-1/16	2-1/4
1	1-5/16	2-5/8
1-1/4	1-21/32	3
1-1/2	1-29/32	3-3/8
2	2-3/8	4-1/8
2-1/2	2-7/8	4-7/8
3	3-1/2	5-3/8
3-1/2	4	6-3/8
4	4-1/2	6-7/8
4-1/2	5	7
5	5-9/16	7-3/4
6	6-5/8	8-3/4
7	7-5/8	10
8	8-5/8	11
10	10-3/4	13-3/8
12	12-3/4	16-1/8
14	14	17-3/4
16	16	20-1/4
18	18	21-5/8
20	20	23-7/8
22	22	26
24	24	28-1/4
26	26	30-1/2
28	28	32-3/4
30	30	34-3/4
32	32	37
34	34	39
36	36	41-1/4
38	38	43-5/8
40	40	45-5/8
42	42	48
46	46	52-1/8
48	48	54-1/2
50	50	56-1/2
52	52	58-3/4
54	54	61
60	60	67-1/2
66	66	74-1/4
72	72	80-3/4
84	84	93-1/2
96	96	106-1/4

RING GASKETS FOR 250/300# ANSI PIPE FLANGES (INCHES)

NOMINAL PIPE SIZE	ID	OD
1/2	27/32	2-1/8
3/4	1-1/16	2-5/8
1	1-5/16	2-7/8
1-1/4	1-21/32	3-1/4
1-1/2	1-29/32	3-3/4
2	2-3/8	4-3/8
2-1/2	2-7/8	5-1/8
3	3-1/2	5-7/8
3-1/2	4	6-1/2
4	4-1/2	7-1/8
4-1/2	5	7-5/8
5	5-9/16	8-1/2
6	6-5/8	9-7/8
7	7-5/8	10-7/8
8	8-5/8	12-1/8
10	10-3/4	14-1/4
12	12-3/4	16-5/8
14	14	19-1/8
15	15	20-1/8
16	16	21-1/4
18	18	23-1/2
20	20	25-3/4
22	22	27-5/8
24	24	30-1/2
30	30	37-1/2
36	36	44
42	42	50-3/4
48	48	58-3/4

* RAGCO supports the autonomy of its locations to select the best products to service their markets. Subtle variations of these specification may exist. Contact your RAGCO affiliate for confirmation.

COMMERCIAL FLANGE DIMENSIONS

FULL FACE GASKETS FOR 125/150# ANSI FLANGES (INCHES)

NOMINAL PIPE SIZE (INCHES)	GASKET ID	GASKET OD	# OF BOLTS	BOLT HOLE DIAMETER	BOLT CIRCLE
1/2	13/16	3-1/2	4	5/8	2-3/8
3/4	1-1/16	3-7/8	4	5/8	2-3/4
1	1-5/16	4-1/4	4	5/8	3-1/8
1-1/4	1-5/8	4-5/8	4	5/8	3-1/2
1-1/2	1-7/8	5	4	5/8	3-7/8
2	2-3/8	6	4	3/4	4-3/4
2-1/2	2-7/8	7	4	3/4	5-1/2
3	3-1/2	7-1/2	4	3/4	6
3-1/2	4	8-1/2	8	3/4	7
4	4-1/2	9	8	3/4	7-1/2
5	5-9/16	10	8	7/8	8-1/2
6	6-5/8	11	8	7/8	9-1/2
8	8-5/8	13-1/2	8	7/8	11-3/4
10	10-3/4	16	12	1	14-1/4
12	12-3/4	19	12	1	17
14	14	21	12	1-1/8	18-3/4
16	16	23-1/2	16	1-1/8	21-1/4
18	18	25	16	1-1/4	22-3/4
20	20	27-1/2	20	1-1/4	25
22	22	29-1/2	20	1-3/8	27-1/4
24	24	32	20	1-3/8	29-1/2
26	26	34-1/4	24	1-3/8	31-3/4
28	28	36-1/2	28	1-3/8	34
30	30	38-3/4	28	1-3/8	36
32	32	41-3/4	28	1-5/8	38-1/2
34	34	43-3/4	32	1-5/8	40-1/2
36	36	46	32	1-5/8	42-3/4
38	38	48-3/4	32	1-5/8	45-1/4
40	40	50-3/4	36	1-5/8	47-1/4
42	42	53	36	1-5/8	49-1/2
44	44	55-1/4	40	1-5/8	51-3/4
46	46	57-1/4	40	1-5/8	53-3/4
48	48	59-1/2	44	1-5/8	56
50	50	61-3/4	44	1-7/8	58-1/4
52	52	64	44	1-7/8	60-1/2
54	54	66-1/4	44	1-7/8	62-3/4
60	60	73	52	1-7/8	69-1/4
66	66	80	52	1-7/8	76
72	72	86-1/2	60	1-7/8	82-1/2
84	84	99-3/4	64	2-1/8	95-1/2
96	96	113-1/4	68	2-3/8	108-1/2



COMMERCIAL FLANGE DIMENSIONS

FULL FACE GASKETS FOR 250/300# ANSI FLANGES (INCHES)

NOMINAL PIPE SIZE (INCHES)	GASKET ID	GASKET OD	# OF BOLTS	BOLT HOLE DIAMETER	BOLT CIRCLE
1	1-5/16	4-7/8	4	3/4	3-1/2
1-1/4	1-21/32	5-1/4	4	3/4	3-7/8
1-1/2	1-29/32	6-1/8	4	7/8	4-1/2
2	2-3/8	6-1/2	8	3/4	5
2-1/2	2-7/8	7-1/2	8	7/8	5-7/8
3	3-1/2	8-1/4	8	7/8	6-5/8
3-1/2	4	9	8	7/8	7-1/4
4	4-1/2	10	8	7/8	7-7/8
5	5-9/16	11	8	7/8	9-1/4
6	6-5/8	12-1/2	12	7/8	10-5/8
8	8-5/8	15	12	1	13
10	10-3/4	17-1/2	16	1-1/8	15-1/4
12	12-3/4	20-1/2	16	1-1/4	17-3/4
14	14	23	20	1-1/4	20-1/4
16	16	25-1/2	20	1-3/8	22-1/2
18	18	28	24	1-3/8	24-3/4
20	20	30-1/2	24	1-3/8	27
22	22	33	24	1-5/8	29-1/4
24	24	36	24	1-5/8	32
26	26	38-1/4	28	1-7/8	34-1/2
28	28	40-3/4	28	1-7/8	37
30	30	43	28	1-7/8	39-1/4
32	32	45-1/4	28	1-7/8	41-1/2
34	34	47-1/2	28	1-7/8	43-1/2
36	36	50	32	2-1/8	46
38	38	52-1/4	32	2-1/8	48
40	40	54-1/2	36	2-1/8	50-1/4
42	42	57	36	2-1/8	52-3/4
44	44	59-1/4	36	2-1/8	55
46	46	61-1/2	40	2-1/8	57-1/4
48	48	65	40	2-1/8	60-3/4

* RAGCO supports the autonomy of its locations to select the best products to service their markets. Subtle variations of these specification may exist. Contact your RAGCO affiliate for confirmation.



COMMERCIAL FLANGE DIMENSIONS

GASKET DIMENSIONS FOR FULL FACE CLASS 400 (INCHES)

NOMINAL PIPE SIZE	GASKET ID	GASKET OD	# OF BOLTS	BOLT HOLE DIAMETER	BOLT CIRCLE
1/4		3 - 3/8	4	5/8	2 - 1/4
1/2	27/32	3 - 3/4	4	5/8	2 - 5/8
3/4	1 - 1/16	4 - 5/8	4	3/4	3 - 1/4
1	1 - 5/16	4 - 7/8	4	3/4	3 - 1/2
1 - 1/4	1 - 21/32	5 - 1/4	4	3/4	3 - 7/8
1 - 1/2	1 - 29/32	6 - 1/8	4	7/8	4 - 1/2
2	2 - 3/8	6 - 1/2	8	3/4	5
2 - 1/2	2 - 7/8	7 - 1/2	8	7/8	5 - 7/8
3	3 - 1/2	8 - 1/4	8	7/8	6 - 5/8
3 - 1/2	4	9	8	1	7 - 1/4
4	4 - 1/2	10	8	1	7 - 7/8
5	5 - 9/16	11	8	1	9 - 1/4
6	6 - 5/8	12 - 1/2	12	1	10 - 5/8
8	8 - 5/8	15	12	1 - 1/8	13
10	10 - 3/4	17 - 1/2	16	1/1/4	15 - 1/4
12	12 - 3/4	20 - 1/2	16	1 - 3/8	17 - 3/4
14	14	23	20	1 - 3/8	20 - 1/4
16	16	25 - 1/2	20	1 - 1/2	22 - 1/2
18	18	28	24	1 - 1/2	24 - 3/4
20	20	30 - 1/2	24	1 - 5/8	27
24	24	36	24	1 - 7/8	32

GASKET DIMENSIONS FOR FULL FACE CLASS 600 (INCHES)

NOMINAL PIPE SIZE	GASKET ID	GASKET OD	# OF BOLTS	BOLT HOLE DIAMETER	BOLT CIRCLE
1/4		3 - 3/8	4	5/8	2 - 1/4
1/2	27/32	3 - 3/4	4	5/8	2 - 5/8
3/4	1 - 1/16	4 - 5/8	4	3/4	3 - 1/4
1	1 - 5/16	4 - 7/8	4	3/4	3 - 1/2
1 - 1/4	1 - 21/32	5 - 1/4	4	3/4	3 - 7/8
1 - 1/2	1 - 29/32	6 - 1/8	4	7/8	4 - 1/2
2	2 - 3/8	6 - 1/2	8	3/4	5
2 - 1/2	2 - 7/8	7 - 1/2	8	7/8	5 - 7/8
3	3 - 1/2	8 - 1/4	8	7/8	6 - 5/8
3 - 1/2	4	9	8	1	7 - 1/4
4	4 - 1/2	10 - 3/4	8	1	8 - 1/2
5	5 - 9/16	13	8	1 - 1/8	10 - 1/2
6	6 - 5/8	14	12	1 - 1/8	11 - 1/2
8	8 - 5/8	16 - 1/2	12	1 - 1/4	13 - 3/4
10	10 - 3/4	20	16	1 - 3/8	17
12	12 - 3/4	22	20	1 - 3/8	19 - 1/4
14	14	23 - 3/4	20	1 - 1/2	20 - 3/4
16	16	27	20	1 - 5/8	23 - 3/4
18	18	29 - 1/4	20	1 - 3/4	25 - 3/4
20	20	32	24	1 - 3/4	28 - 1/2
24	24	37	24	2	33



COMMERCIAL FLANGE DIMENSIONS

FULL FACE FLANGE DIMENSIONS CLASS 900 (INCHES)

NOMINAL PIPE SIZE	DIAMETER OF FLANGE	# OF BOLTS	BOLT HOLE DIAMETER	BOLT CIRCLE
1/2	4-3/4	4	3/4	3-1/4
3/4	5-1/8	4	3/4	3-1/2
1	5-7/8	4	7/8	4
1-1/4	6-1/4	4	7/8	4-3/8
1-1/2	7	4	1	4-7/8
2	8-1/2	8	7/8	6-1/2
2-1/2	9-5/8	8	1	7-1/2
3	9-1/2	8	7/8	7-1/2
4	11-1/2	8	1-1/8	9-1/4
5	13-3/4	8	1-1/4	11
6	15	12	1-1/8	12-1/2
8	18-1/2	12	1-3/8	15-1/2
10	21-1/2	16	1-3/8	18-1/2
12	24	20	1-3/8	21
14	25-1/4	20	1-1/2	22
16	27-3/4	20	1-5/8	24-1/2
18	31	20	1-7/8	27
20	33-3/4	20	2	29-1/2
24	41	20	2-1/2	35-1/2

FULL FACE FLANGE DIMENSIONS CLASS 1500 (INCHES)

NOMINAL PIPE SIZE	DIAMETER OF FLANGE	# OF BOLTS	BOLT HOLE DIAMETER	BOLT CIRCLE
1/2	4-3/4	4	3/4	3-1/4
3/4	5-1/8	4	3/4	3-1/2
1	5-7/8	4	7/8	4
1-1/4	6-1/4	4	7/8	4-3/8
1-1/2	7	4	1	4-7/8
2	8-1/2	8	7/8	6-1/2
2-1/2	9-5/8	8	1	7-1/2
3	10-1/2	8	1-1/8	8
4	12-1/4	8	1-1/4	9-1/2
5	14-3/4	8	1-1/2	11-1/2
6	15-1/2	12	1-3/8	12-1/2
8	19	12	1-5/8	15-1/2
10	23	12	1-7/8	19
12	26-1/2	16	2	22-1/2
14	29-1/2	16	2-1/4	25
16	32-1/2	16	2-1/2	27-3/4
18	36	16	2-3/4	30-1/2
20	38-3/4	16	3	32-3/4
24	46	16	3-1/2	39

* RAGCO supports the autonomy of its locations to select the best products to service their markets. Subtle variations of these specification may exist. Contact your RAGCO affiliate for confirmation.

COMMERCIAL FLANGE DIMENSIONS

FULL FACE FLANGE DIMENSIONS CLASS 2500 (INCHES)

NOMINAL PIPE SIZE	DIAMETER OF FLANGE	# OF BOLTS	BOLT HOLE DIAMETER	BOLT CIRCLE
1/2	5-1/4	4	3/4	3-1/2
3/4	5-1/2	4	3/4	3-3/4
1	6-1/4	4	7/8	4-1/4
1-1/4	7-1/4	4	1	5-1/8
1-1/2	8	4	1-1/8	5-3/4
2	9-1/4	8	1	6-3/4
2-1/2	10-1/2	8	1-1/8	7-3/4
3	12	8	1-1/4	9
4	14	8	1-1/2	10-3/4
5	16-1/2	8	1-3/4	12-3/4
6	19	8	2	14-1/2
8	21-3/4	12	2	17-1/4
10	26-1/2	12	2-1/2	21-1/4
12	30	12	2-3/4	24-3/8



SPIRAL WOUND GASKETS

GASKET SELECTION

What Style of Gasket Should I Select?



Style CG - Utilizes an external ring which accurately centers gasket on flange face, provides additional radial strength to prevent gasket blow-out and acts as a compression stop. A general purpose gasket suitable for use with flat face and raised face flanges up to and inclusive of class 2500.

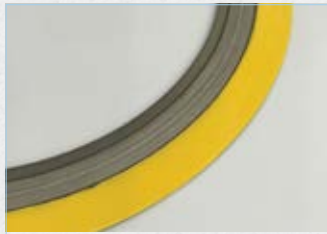

Style CGI - A Style CG gasket fitted with internal ring which gives an additional compression limiting stop and provides heat and corrosion barrier protecting gasket windings and preventing flange erosion. Suitable for use with flat face and raised face flanges.



Style R - Basic construction type. Inner and outer diameters are reinforced with several plies of metal without filler to give greater stability and better compression and sealing characteristics. Suitable for tongue and groove or male and female flange assemblies.

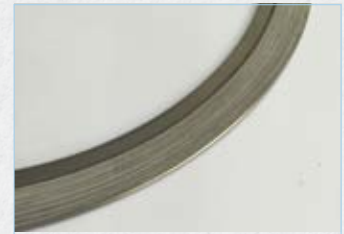

Style RIR - Solid inner metal ring acts as a compression stop and fills the annular space between flange bore and the inside diameter of the gasket. Designed to prevent accumulation of solids, reduce turbulent flow of process fluids and minimize erosion at flange faces. Suitable for male and female pipe flanges.

SELECTION GUIDE

Published as an indication of which spiral wound gasket best suits different pipe flange configurations and service conditions.

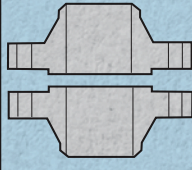
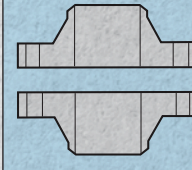
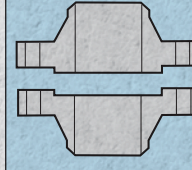
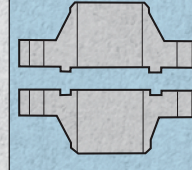
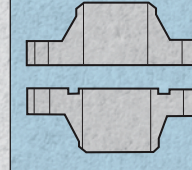
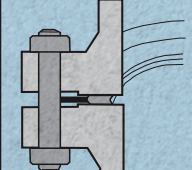
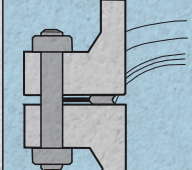
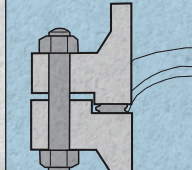
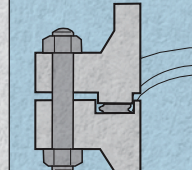
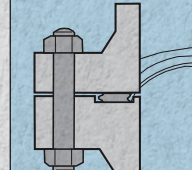
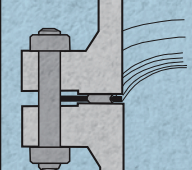
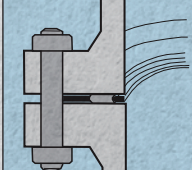
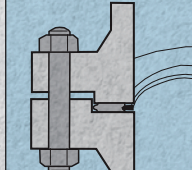
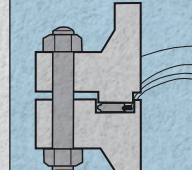
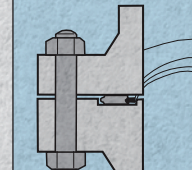
FLANGE FACE	 Raised Face	 Flat Face	 Male and Female	 Tongue and Groove	 Flat Face to Recess
RECOMMENDED GASKET STYLE For general duties	 Style CG	 Style CG	 Style R*	 Style R*	 Style R*
RECOMMENDED GASKET STYLE For high pressure/-temperature duty, also for gaskets with PTFE filler, corrosive or fluctuating pressure or temperature service conditions.	 Style CGI**	 Style CGI**	 Style RIR**	 Style RIR**	 Style RIR**

* It is essential that Style R gaskets are fitted with a compression stop. Without a correctly dimensioned stop the gasket can easily be over-compressed resulting in failure. To provide a compression stop the depth of the tongue, groove or recess should be controlled to provide optimum compressed gasket thickness with metal to metal contact on the flange faces.

STYLE CG & CGI GASKETS

STYLE CG & CGI GASKETS To Suit Standard Raised Face And Flat Face Flanges

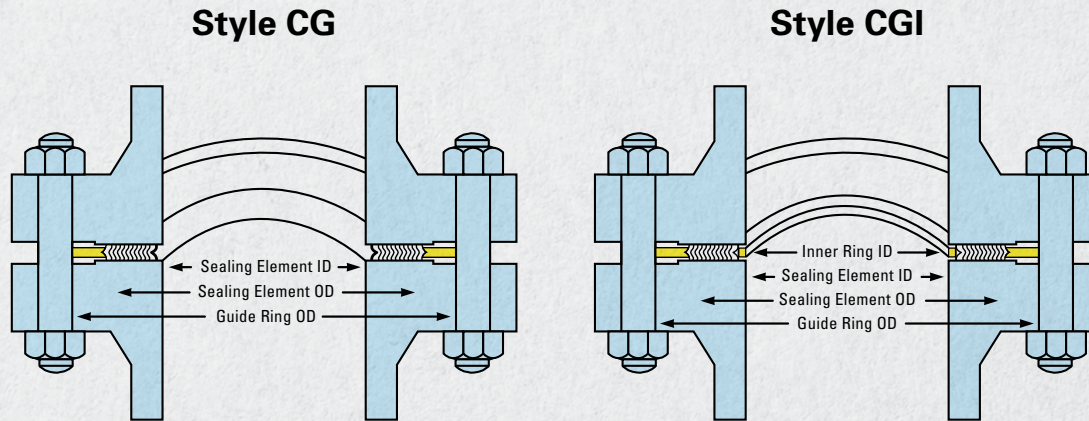

All CG and CGI Gaskets for these standard flanges are 0.175 in (4.5mm) thick, fitted with 0.125 in (3.2mm) thick solid metal rings, unless otherwise stated.

SPECIAL GASKETS

Gaskets of special design can be engineered and fabricated using the same basic fundamentals of Spiral Wound Gasket design and construction to cover a wide range of applications in installations for which there are no industry-wide standards. Special gaskets have been designed for valves, pumps, compressors, turbines, boilers, heat exchangers, etc. Consult with your Ragco location as early in the design stage as possible.

GOVERNMENT SPECIFICATIONS

Spiral Wound Gaskets are available in accordance with Military Specification MIL-G-24716.

Style CG and CGI Spiral Wound gaskets can be manufactured in accordance with all relevant gasket standards to suit the following flange designations.

Please note that gaskets for non-standard flanges are also readily available.

ASME B16.5
 BS 1560
 BS 10
 ASME B16.47 SERIES B (API 605)
 ASME B16.47 SERIES A (MSS SP 44)
 BS 4504
 DIN FLANGES
 JIS FLANGES

WHEN ORDERING PLEASE SPECIFY

- GASKET STYLE (Example: Flexitallic Style "CGI" Spiral Wound Gasket)
- NOMINAL PIPE SIZE (NPS) (Example: 4 inches)
- PRESSURE RATING (Example: Class 900)
- GASKET STANDARD (Example: ASME B16.20)
- WINDING MATERIALS (Example: 316SS)
- OUTER RING MATERIAL (Example: Carbon Steel)
- INNER RING MATERIAL (Example: 316SS)

* RAGCO supports the autonomy of its locations to select the best products to service their markets. Subtle variations of these specification may exist. Contact your RAGCO affiliate for confirmation.

STYLE CG & CGI* TO ASME B16.20

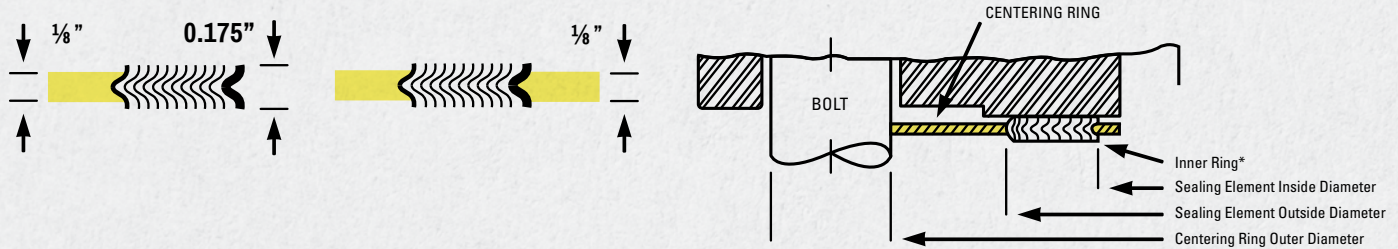

TABLE 1: Style CG & CGI* to ASME B16.20 To Suit ASME B16.5 Flanges (INCHES)

Nom Pipe Size	OUTSIDE DIAMETER OF SEALING ELEMENT		INNER DIAMETER OF SEALING ELEMENT							OUTER DIAMETER OF CENTERING RING						
	Class 150, 300, 400, 600	Class 900, 1500, 2500	Class 150	Class 300	Class 400	Class 600	Class 900	Class 1500	Class 2500	Class 150	Class 300	Class 400	Class 600	Class 900	Class 1500	Class 2500
1/4	7/8		1/2	1/2	1/2	1/2	-	-	-	1-3/4	1-3/4	1-3/4	1-3/4	-	-	-
1/2	1-1/4	1-1/4	3/4	3/4	3/4	3/4	3/4	3/4	3/4	1-7/8	2-1/8	2-1/8	2-1/8	2-1/2	2-1/2	2-3/4
3/4	1-9/16	1-9/16	1	1	1	1	1	1	1	2-1/4	2-5/8	2-5/8	2-5/8	2-3/4	2-3/4	3
1	1-7/8	1-7/8	1-1/4	1-1/4	1-1/4	1-1/4	1-1/4	1-1/4	1-1/4	2-5/8	2-7/8	2-7/8	2-7/8	3-1/8	3-1/8	3-3/8
1-1/4	2-3/8	2-3/8	1-7/8	1-7/8	1-7/8	1-7/8	1-9/16	1-9/16	1-9/16	3	3-1/4	3-1/4	3-1/4	3-1/2	3-1/2	4-1/8
1-1/2	2-3/4	2-3/4	2-1/8	2-1/8	2-1/8	2-1/8	1-7/8	1-7/8	1-7/8	3-3/8	3-3/4	3-3/4	3-3/4	3-7/8	3-7/8	4-5/8
2	3-3/8	3-3/8	2-3/4	2-3/4	2-3/4	2-3/4	2-5/16	2-5/16	2-5/16	4-1/8	4-3/8	4-3/8	4-3/8	5-5/8	5-5/8	5-3/4
2-1/2	3-7/8	3-7/8	3-1/4	3-1/4	3-1/4	3-1/4	2-3/4	2-3/4	2-3/4	4-7/8	5-1/8	5-1/8	5-1/8	6-1/2	6-1/2	6-5/8
3	4-3/4	4-3/4	4	4	4	4	3-3/4	3-5/8	3-5/8	5-3/8	5-7/8	5-7/8	5-7/8	6-5/8	6-7/8	7-3/4
3-1/2	5-1/4	5-1/4	4-1/2	4-1/2	4-1/8	4-1/8	4-1/8	4-1/8	-	6-3/8	6-1/2	6-3/8	6-3/8	7-1/2	7-3/8	-
4	5-7/8	5-7/8	5	5	4-3/4	4-3/4	4-3/4	4-5/8	4-5/8	6-7/8	7-1/8	7	7-5/8	8-1/8	8-1/4	9-1/4
4-1/2	6-1/2	6-1/2	5-1/2	5-1/2	5-5/16	5-5/16	5-5/16	5-5/16	-	7	7-3/4	7-5/8	8-1/4	9-3/8	9-1/8	-
5	7	7	6-1/8	6-1/8	5-13/16	5-13/16	5-13/16	5-5/8	5-5/8	7-3/4	8-1/2	8-3/8	9-1/2	9-3/4	10	11
6	8-1/4	8-1/4	7-3/16	7-3/16	6-7/8	6-7/8	6-7/8	6-3/4	6-3/4	8-3/4	9-7/8	9-3/4	10-1/2	11-3/8	11-1/8	12-1/2
8	10-3/8	10-1/8	9-3/16	9-3/16	8-7/8	8-7/8	8-3/4	8-1/2	8-1/2	11	12-1/8	12	12-5/8	14-1/8	13-7/8	15-1/4
10	12-1/2	12-1/4	11-5/16	11-5/16	10-13/16	10-13/16	10-7/8	10-1/2	10-5/8	13-3/8	14-1/4	14-1/8	15-3/4	17-1/8	17-1/8	18-3/4
12	14-3/4	14-1/2	13-3/8	13-3/8	12-7/8	12-7/8	12-3/4	12-3/4	12-1/2	16-1/8	16-5/8	16-1/2	18	19-5/8	20-1/2	21-5/8
14	16	15-3/4	14-5/8	14-5/8	14-1/4	14-1/4	14	14-1/4	-	17-3/4	19-1/8	19	19-3/8	20-1/2	22-3/4	-
16	18-1/4	18	16-5/8	16-5/8	16-1/4	16-1/4	16-1/4	16	-	20-1/4	21-1/4	21-1/8	22-1/4	22-5/8	25-1/4	-
18	20-3/4	20-1/2	18-11/16	18-11/16	18-1/2	18-1/2	18-1/4	18-1/4	-	21-5/8	23-1/2	23-3/8	24-1/8	25-1/8	27-3/4	-
20	22-3/4	22-1/2	20-11/16	20-11/16	20-1/2	20-1/2	20-1/2	20-1/4	-	23-7/8	25-3/4	25-1/2	26-7/8	27-1/2	29-3/4	-
24	27	26-3/4	24-3/4	24-3/4	24-3/4	24-3/4	24-3/4	24-1/4	-	28-1/4	30-1/2	30-1/4	31-1/8	33	35-1/2	-

*For Style CGI - see Table 3 for Inner Ring dimensions.

Gasket sizes 1/4" to 3" Class 300, 400 & 600 as well as sizes 1/2" to 2-1/2" Class 900 & 1500 are identical within their respective nominal pipe sizes, therefore inventories need not be duplicated.

In accordance with ASME B16.20, Inner Rings are mandatory for the following flange designations (see Table 3).

- Class 900 - NPS 24 to 48
- Class 1500 - NPS 12 to NPS 24
- Class 2500 - NPS 4 to NPS 12
- All PTFE filled gaskets
- All flexible graphite gaskets unless otherwise requested by the customer

ASME B16.20 does not include dimensions for NPS 1/4, 3/2, or 4 1/2, or Class 400 Flanges up to NPS 3 and Class 900 Flanges up to NPS 2 1/2.



STYLE CG & CGI* TO ASME B16.20

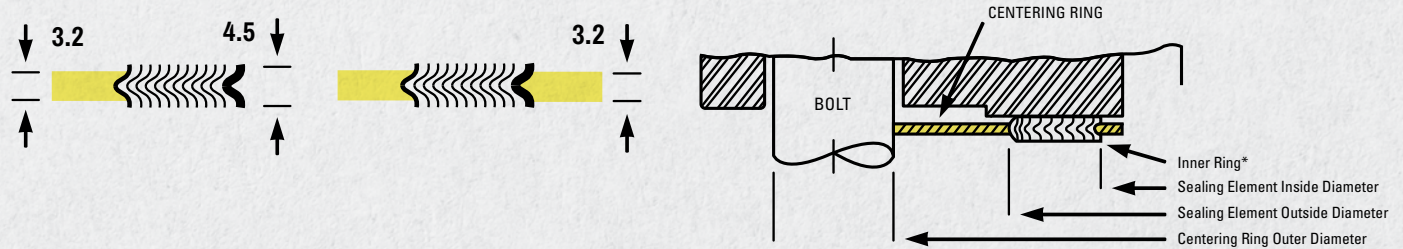

TABLE 2: Style CG & CGI* to ASME B16.20 To Suit ASME B16.5 Flanges (MILLIMETERS)

Nom Pipe Size	OUTSIDE DIAMETER OF SEALING ELEMENT		INNER DIAMETER OF SEALING ELEMENT							OUTER DIAMETER OF CENTERING RING						
	Class 150, 300, 400, 600	Class 900, 1500, 2500	Class 150	Class 300	Class 400	Class 600	Class 900	Class 1500	Class 2500	Class 150	Class 300	Class 400	Class 600	Class 900	Class 1500	Class 2500
1/4	22.2	-	12.7	12.7	12.7	12.7	-	-	-	44.5	44.5	44.5	44.5	-	-	-
1/2	31.8	31.8	19.1	19.1	19.1	19.1	19.1	19.1	19.1	47.8	54.1	54.1	54.1	63.5	63.5	69.9
3/4	39.6	39.6	25.4	25.4	25.4	25.4	25.4	25.4	25.4	57.2	66.8	66.8	66.8	69.9	69.9	76.2
1	47.8	47.8	31.8	31.8	31.8	31.8	31.8	31.8	31.8	66.8	73.2	73.2	73.2	79.5	79.5	85.9
1-1/4	60.5	60.5	47.8	47.8	47.8	47.8	39.6	39.6	39.6	76.2	82.6	82.6	82.6	88.9	88.9	104.9
1-1/2	69.9	69.9	54.1	54.1	54.1	54.1	47.8	47.8	47.8	85.9	95.3	95.3	95.3	98.6	98.6	117.6
2	85.9	85.9	69.9	69.9	69.9	69.9	58.7	58.7	58.7	104.9	111.3	111.3	111.3	143	143	146.1
2-1/2	98.6	98.6	82.6	82.6	82.6	82.6	69.9	69.9	69.9	124	130.3	130.3	130.3	165.1	165.1	168.4
3	120.7	120.7	101.6	101.6	101.6	101.6	95.3	92.2	92.2	136.7	149.4	149.4	149.4	168.4	174.8	196.9
3-1/2	133.4	133.4	114.3	114.3	104.8	104.8	104.8	104.8	-	161.9	165.1	161.9	161.9	190.5	187.3	-
4	149.4	149.4	127	127	120.7	120.7	120.7	117.6	117.6	174.8	181.1	177.8	193.8	206.5	209.6	235
4-1/2	165.1	165.1	139.7	139.7	134.9	134.9	134.9	134.9	-	177.8	196.9	193.7	209.6	238.1	231.8	-
5	177.8	177.8	155.7	155.7	147.6	147.6	147.6	143	143	196.9	215.9	212.9	241.3	247.7	254	279.4
6	209.6	209.6	182.6	182.6	174.8	174.8	174.8	171.5	171.5	222.3	251	247.7	266.7	289.1	282.7	317.5
8	263.7	257.3	233.4	233.4	225.6	225.6	222.3	215.9	215.9	279.4	308.1	304.8	320.8	358.9	352.6	387.4
10	317.5	311.2	287.3	287.3	274.6	274.6	276.4	266.7	270	339.9	362	358.9	400.1	435.1	435.1	476.3
12	374.7	368.3	339.9	339.9	327.2	327.2	323.9	323.9	317.5	409.7	422.4	419.1	457.2	498.6	520.7	549.4
14	406.4	400.1	371.6	371.6	362	362	355.6	362	-	450.9	485.9	482.6	492.3	520.7	577.9	-
16	463.6	457.2	422.4	422.4	412.8	412.8	412.8	406.4	-	514.4	539.8	536.7	565.2	574.8	641.4	-
18	527.1	520.7	474.7	474.7	469.9	469.9	463.6	463.6	-	549.4	596.9	593.9	612.9	638.3	704.9	-
20	577.9	571.5	525.5	525.5	520.7	520.7	520.7	514.4	-	606.6	654.1	647.7	682.8	698.5	755.7	-
24	685.8	679.5	628.7	628.7	628.7	628.7	628.7	616	-	717.6	774.7	768.4	790.7	838.2	901.7	-

*For Style CGI - see Table 3 for Inner Ring dimensions.

Gasket sizes 1/4" to 3" Class 300, 400 & 600 as well as sizes 1/2" to 2-1/2" Class 900 & 1500 are identical within their respective nominal pipe sizes, therefore inventories need not be duplicated.

In accordance with ASME B16.20, Inner Rings are mandatory for the following flange designations (see Table 3).

- Class 900 - NPS 24 to 48
- Class 1500 - NPS 12 to NPS 24
- Class 2500 - NPS 4 to NPS 12
- All PTFE filled gaskets
- All flexible graphite gaskets unless otherwise requested by the customer

ASME B16.20 does not include dimensions for NPS 1/4, 3 1/2, or 4 1/2, or Class 400 Flanges up to NPS 3 and Class 900 Flanges up to NPS 2 1/2.

* RAGCO supports the autonomy of its locations to select the best products to service their markets. Subtle variations of these specification may exist. Contact your RAGCO affiliate for confirmation.

TABLE 3: STANDARD INSIDE DIAMETERS OF INNER RINGS FOR STYLE CGI GASKETS TO ASME B16.20 TO SUIT ASME B16.5 FLANGES (INCHES & MILLIMETERS)

NOM PIPE SIZE (in)	PRESSURE CLASS													
	150		300		400		600		900		1500		2500	
	(in)	(mm)	(in)	(mm)	(in)	(mm)	(in)	(mm)	(in)	(mm)	(in)	(mm)	(in)	(mm)
1/2	0.56	14.22	0.56	14.22	0.56	14.22	0.56	14.22	0.56	14.22	0.56	14.22	0.56	14.22
3/4	0.81	20.57	0.81	20.57	0.81	20.57	0.81	20.57	0.81	20.57	0.81	20.57	0.81	20.57
1	1.06	26.92	1.06	26.92	1.06	26.92	1.06	26.92	1.06	26.92	1.06	26.92	1.06	26.92
1-1/4	1.50	38.10	1.50	38.10	1.50	38.10	1.50	38.10	1.31	33.27	1.31	33.27	1.31	33.27
1-1/2	1.75	44.45	1.75	44.45	1.75	44.45	1.75	44.45	1.63	41.40	1.63	41.40	1.63	41.40
2	2.19	55.63	2.19	55.63	2.19	55.63	2.19	55.63	2.06	52.32	2.06	52.32	2.06	52.52
2-1/2	2.62	66.55	2.62	66.55	2.62	66.55	2.62	66.55	2.50	63.60	2.50	63.50	2.50	63.50
3	3.19	81.03	3.19	81.03	3.19	81.03	3.19	81.03	3.10	78.74	3.10	78.74	3.10	78.74
4	4.19	106.43	4.19	106.43	4.04	102.62	4.04	102.62	4.04	102.62	3.85	97.79	3.85	97.79
5	5.19	131.83	5.19	131.63	5.05	128.27	5.05	128.27	5.05	128.27	4.90	124.46	4.90	124.46
6	6.19	157.23	6.19	157.23	6.10	154.64	6.10	154.94	6.10	154.95	5.80	147.32	5.80	147.32
8	8.50	215.90	8.50	215.90	8.10	205.74	8.10	205.74	7.75	196.85	7.75	196.85	7.75	196.85
10	10.56	288.22	10.56	268.22	10.05	255.27	10.05	255.27	9.69	246.13	9.69	246.13	9.69	246.13
12	12.50	317.50	12.50	317.50	12.10	307.34	12.10	307.34	11.50	292.10	11.50	292.10	11.50	292.10
14	13.75	349.28	13.75	349.25	13.50	342.80	13.50	342.90	12.63	320.80	12.63	320.80	-	-
16	15.75	400.05	15.75	400.05	15.35	389.89	15.35	389.89	14.75	374.65	14.50	388.30	-	-
18	17.69	449.33	17.69	449.33	17.25	438.15	17.25	438.15	16.75	425.45	16.75	425.45	-	-
20	19.69	500.13	19.69	500.13	19.25	488.95	19.25	488.95	19.00	482.60	18.75	476.25	-	-
24	23.75	603.25	23.75	603.25	23.25	590.55	23.25	590.65	23.25	590.55	22.75	577.85	-	-

In accordance with ASME B16.20, Inner Rings are mandatory for the following flange designations (see Table 3).

- Class 900 - NPS 24 to 48
 - All PTFE filled gaskets
- Class 1500 - NPS 12 to NPS 24
 - All flexible graphite gaskets unless otherwise requested by the customer
- Class 2500 - NPS 4 to NPS 12

ASME B16.20 does not include dimensions for NPS ¼, 3 ½, or 4 ½, or Class 400 Flanges up to NPS 3 and Class 900 Flanges up to NPS 2 ½.



STYLE CG & CGI

To Suit ASME B16.5 & BS 1560 Small Diameter Screwed or Slip-On Flanges



TABLE 4: STYLE CG & CGI To Suit ASME B16.5 & BS 1560 Small Diameter Screwed or Slip-On Flanges (INCHES & MILLIMETERS)

NOM PIPE SIZE (in)	Inner Ring Diameter		SEALING ELEMENT				GUIDE RING OUTSIDE DIAMETER											
			Inside Dia.		Outside Dia.		Class 150		Class 300		Class 400		Class 600		Class 900		Class 1500	
	(in)	(mm)	(in)	(mm)	(in)	(mm)	(in)	(mm)	(in)	(mm)	(in)	(mm)	(in)	(mm)	(in)	(mm)	(in)	(mm)
1/4	-	-	9/16	14.3	7/8	22.2	1-3/4	44.5	1-3/4	44.5	1-3/4	44.5	1-3/4	44.5	-	-	-	-
1/2	9/16	14.3	15/16	23.8	1-1/4	31.8	1-7/8	47.6	2-1/8	54.0	2-1/8	54.0	2-1/8	54.0	2-1/2	63.5	2-1/2	63.5
3/4	13/16	20.6	1-3/16	30.2	1-9/16	39.7	2-1/4	57.2	2-5/8	66.7	2-5/8	66.7	2-5/8	66.7	2-3/4	69.9	2-3/4	69.9
1	1-1/16	27.0	1-7/16	36.5	1-7/8	47.6	2-5/8	66.7	2-7/8	73.0	2-7/8	73.0	2-7/8	73.0	3-1/8	79.4	3-1/8	79.4
1-1/4	1-3/8	34.9	1-7/8	47.6	2-3/8	60.3	3	76.2	3-1/4	82.6	3-1/4	82.6	3-1/4	82.6	3-1/2	88.9	3-1/2	88.9
1-1/2	1-5/8	41.3	2-1/8	54.0	2-3/4	69.9	3-3/8	85.7	3-3/4	95.3	3-3/4	95.3	3-3/4	95.3	3-7/8	98.4	3-7/8	98.4

NOTE: The above style CG & CGI spiral wound gaskets are dimensioned to suit existing screwed or slip-on flanges for NPS 1/4 to 1-1/2 ASME B16.5 & BS 1560 flanges.

SPIRAL WOUND MANWAY & HANDHOLE GASKETS

Gaskets for boiler handhole, tubecap and manhole covers incorporating the unique Flexitallic Spiral Wound profile and specially manufactured with graphite filler, are ideal for corrosive, high pressure or temperature duties. Flexitallic's anticipation of developments in modern steam generating and engineering equipment and ability to design to specific requirements are the guarantee of the perfect seal at minimum maintenance cost with consistently high standards of performance.

- High safety factor related to specific operating conditions
- Resilient under concentrated and fluctuating loads
- Compression loadings proportional to safe stresses of cover assemblies
- Prolonged trouble-free service
- Reduced seat cleaning time



Elliptical Handhole Gasket



Diamond Shaped Handhole Gasket



Elliptical Manway Gasket



Style M Gaskets

Style MC Gaskets

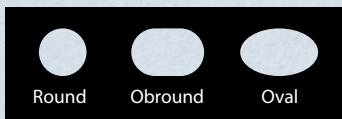

Round

Obround

Oval

STYLE M & MC & MCS

Spiral Wound Gaskets for Boiler Manhole Cover Assemblies

The manhole gasket spiral constructions incorporate modified compression values to provide seating loads within the normal range of cover assemblies.

SIZE/RANGE SPECIFICATION: Available in circular, obround, and oval shapes to suit standard manhole plate configurations.



Style T Gaskets

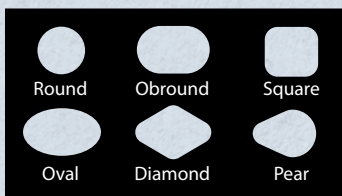

Round

Obround

Square

Oval

Diamond

Pear

STYLE T

Spiral Wound Gaskets for Boiler Handhole and Tubecap Assemblies

The design features of the basic spiral wound construction alleviate the need for sealing compound. Particularly suitable where old and pitted faces have rendered other gaskets ineffective.

SIZE/RANGE SPECIFICATION: Available in several standard shapes - Supplied in thicknesses of 3.2mm (0.125in.) or 4.5mm (0.175 in.). The standard thickness of 4.5mm (0.175in.) is recommended for use in assemblies where the seat is relatively broad and bolting load is low.

MATERIALS

Standard materials are Type 304 Stainless Steel and graphite windings. Special materials to suit specific operating conditions are available.

TO ORDER

Submit the following with all inquiries: 1) Name of boiler or equipment manufacturer; 2) Gasket style; 3) Dimensions of gasket; 4) Gasket thickness; 5) Flange width of gasket; 6) Pressure service rating; 7) Gasket material preference

STYLES M & MC

For Manhole Cover Assemblies

STYLES M & MC FOR MANHOLE COVER ASSEMBLIES

STYLE	NOMINAL I.D. DIMENSIONS (IN)	THICKNESS (IN)	FLANGE WIDTH (IN)
M-Oval	10 x 15	0.250	15/16
M-Oval	10 x 16	0.250	15/16
M-Oval	11 x 15	0.250	15/16
MC-Oval	11 x 15	0.250	13/16
M-Oval	11 x 15	0.175	3/4
M-Oval	11 x 15	0.175	15/16
M-Oval	11 x 15	0.175	1/2
M-Oval	11 x 15	0.175	1-1/4
M-Oval	11 x 15	0.250	1-1/4
M-Obround	11-1/16 x 14-7/8	0.250	15/16
M-Obround	11-7/16 x 15-1/16	0.250	15/16
M-Oval	12 x 16	0.250	15/16
MC-Oval	12 x 16	0.250	13/16
M-Oval	12 x 16	0.175	1/2
M-Oval	12 x 16	0.175	3/4
M-Oval	12 x 16	0.175	15/16
M-Oval	12 x 16	0.175	1-1/4
M-Oval	12 x 16	0.250	1-1/4
M-Obround	12 x 16	0.250	15/16
M-Obround	12 x 16	0.250	1-1/4
MC-Oval	12-1/8 x 16-1/8	0.250	13/16
M-Obround	14 x 16	0.175	3/4
M-Round	14	0.175	3/4
M-Round	16-1/16	0.175	3/4

NOTE: When ordering gaskets specify operating pressure and temperature and type of steel desired.

STYLE MCS SPIRAL WOUND GASKETS

In keeping with our tradition of taking a leadership role in the gasket industry we are pleased to introduce the style MCS spiral wound gasket for use on boiler manhole cover assemblies. The style MCS gasket is an exclusive design, consisting of a spiral wound gasket with an integral solid metal inner ring. The spiral wound sealing element provides resilience, strength, blowout resistance and superior sealability. The solid metal ring prevents over-compression of the gasket, which is especially important on high pressure boilers. In addition, the rings provide stability and facilitate proper positioning of the gasket on the cover which prevents pinching, shouldering, and other gasket damage resulting from misalignment, irregular plate contours and fillets.

Style MCS spiral wound gaskets are available in a wide range of materials for standard, as well as special design manhole cover assemblies, in pressure classes of 0-499 psi, 0-999 psi, and 1000 psi and higher. For additional information or style MCS spiral wound gaskets, contact the Ragco location nearest you.

STYLE M

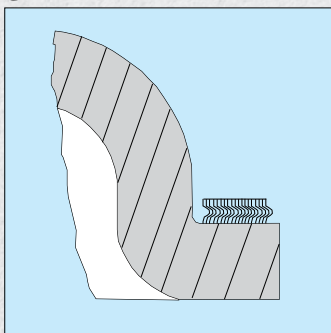

STYLE MC

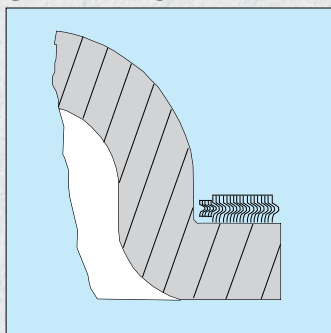

STYLE MCS

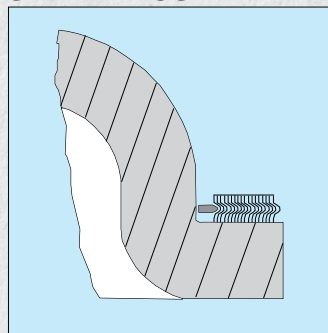

* RAGCO supports the autonomy of its locations to select the best products to service their markets. Subtle variations of these specification may exist. Contact your RAGCO affiliate for confirmation.

STYLE T FOR BOILER HANDHOLE AND TUBECAP ASSEMBLIES

0-499 lbs, 0-999 lbs, 1000 lbs and above. Specify operating temperature, pressure and type of steel.

IDENTIFICATION	SHAPE	NOMINAL I.D. (IN)	FLANGE WIDTH (IN)	IDENTIFICATION	SHAPE	NOMINAL I.D. (IN)	FLANGE WIDTH (IN)
American Engineering	Obround Round	3-5/16 x 3-11/16 3-5/16	3/16 3/16	Foster Wheeler (con't)	Round Round Rectangular	3-1/8 or 3-1/16 4-1/8 or 4-1/16 4-15/16 x 5-3/16	3/8 3/8 7/32
Babcock and Wilcox				Geary			
No.41	Obround	2-9/64 x 2-33/64	5/32	31/2"	Obround	3-13/16 x 4-5/8	3/8
No.40	Diamond	3-3/8 x 3-3/4	3/16	4"	Obround	4-1/4 x 5-1/4	7/16
No.48	Oval	3-13/16 x 4-3/4	7/32	4" (.285" Thick)	Obround	4-1/4 x 5 1/4	7/16
No.79	Obround	4-5/32 x 4-25/32	1/4	Heine	Obround	3-5/8 x 4-5/8	3/8
No.24	Oval	4-1/2 x 5-1/2	7/32	Round	Round	3-5/8	3/8
No.76	Oval	5-1/32 x 5-31/32	1/4	International	Oval	2-19/32 x 3-19/32	7/16
2" Econ.	Round	1-5/8	1/4	Keeler	Diamond	4-1/4x 5-1/4	3/8
No.47	Round	2-1/32	3/16	Round	Round	4-1/4	3/8
No.32	Round	3	1/4	Obround	Obround	3 x 4	3/8
No.70	Round	3-9/32	3/16	Murray	Obround	3-5/8 x 4-9/16	3/8
No.89	Round	3-7/16	5/32	Obround	Obround	3-5/8 x 4-9/16	7/16
No.92	Round	4-1/32	1/4	Obround	Obround	4-1/32 X 4-29/32	3/8
No.28	Rectangular	4-13/16 x 5	7/32	Oil Field	Obround	2-1/2 x 3-1/2	3/8
Badenhausen (See Riley Stoker)				Oval	Oval	3 x 4	3/8
Bros				Oval	Oval	3-1/2 x 4-1/2	3/8
HB-5 and HB-10	Round	2-1/4	1/4	Oval	Oval	4-1/16 x 5-1/16	7/16
HB-6 and HB-11	Round	3-3/8	1/4	Orr & Sembower	Oval	2-23/32 x 3-21/32	3/8
HB-12	Round	4-1/4	1/4	Oval	Oval	3-13/32 x 4-13/32	3/8
HB-8 and HB-13	Obround	3-3/8 x 4-1/4	1/4	Pacific	Round	1-1/2	1/2
HB-14	Obround	4-1/4 x 5	1/4	Round	Round	2	1/2
Bucyrus-Erie				2-1/2		2-1/2	1/2
Q227	Obround	3 x 4-1/2	3/8	Page			
O260	Oval	4 x 6	7/16	Larrabee	Oval	2-27/32 x 3-29/32	3/8
O208	Round	2-1/2	1/4	Junior	Oval	3-1/8 x 4-1/8	3/8
Casey-Hedges	Obround	4-1/4 x 5-1/8	3/8	Page	Oval	3-1/8 x 4-1/4	3/8
Cleaver-Brooks	Obround	2-27/32 x 3-19/32	5/16	P-B	Oval	3-5/16 x 4-5/16	3/8
	Obround	3-9/32 x 4-17/32	3/8	Drum	Oval	3-25/32 x 5-13/32	5/8
	Obround	4 x 6	3/8	Consol	Round	2-3/16	3/8
Combustion Engineering				Riley Stoker			
24N-L1206	Diamond	3 x 3-7/8	1/4	W-C22	Oval	3-17/32 x 4-17/32	5/16
29N-L839	Diamond	3-3/8 x 4-1/4	1/4	W-C2	Obround	3-23/32 x 5-23/32	11/32
30N-L866	Diamond	3-5/8 x 4-1/2	1/4	W-C16	Round	1-31/32	3/8
33N-L1205	Diamond	3-3/4 x 4-5/8	1/4	W-C6	Round	3-9/32	5/16
31N-L579	Diamond	4-1/4 x 5-1/8	1/4	W-C9	Square	4 x 4	11/32
21N-L1291	Obround	2-1/8 x 2-1/2	5/32	Square	Square	5-1/2 x 5-1/2	3/8
22N	Oval	2-1/8 x 2-5/8	7/32	Springfield	Oval	3-17/32 x 4-17/32	5/16
23N	Obround	2-25/32 x 3-13/32	7/32	Oval	Oval	4-1/16 x 5-1/16	3/8
25N-L1 278	Obround	3-1/8 x 4-1/8	3/16	Square	Square	5-1/2 x 5-1/2	3/8
27N	Diamond	3-3/8 x 3-3/4	3/16	Square	Square	7-3/8 x 7-3/8	5/8
28N-L1277	Obround	3-3/8 x 3-7/8	3/16	Superheater	Obround	2-21/32 x 3-9/32	15/64
32N	Oval	4-1/2 x 5-1/2	7/32	Obround	Obround	3-3/32 x 4-3/32	1/4
1N-L1272	Round	1-1/2	3/16	Obround	Obround	3-11/32 x 3-23/32	3/16
7N-L1131	Round	1-3/4	3/16	Obround	Obround	3-3/8 x 3-3/8	1/4
3N-L1274	Round	2-5/8	7/32	Round	Round	15/16	3/16
4N-L740	Round	3-1/8	1/4	Round	Round	3-3/32	1/4
L741	Round	3-3/8	1/4	Union			
5N-L902	Round	3-5/8	1/4	3 1/4"	Pear	3-7/16 x 4-7/16	3/8
5N-L744	Round	4-1/8	1/4	Pear	Pear	3-1/2 x 4-1/2	3/8
51N	Rectangular	4-13/16 x 5	7/32	Pear	Pear	4-1/4 x 5-1/4	3/8
52N-L1117	Rectangular	4-7/8 x 5-3/16	7/32	(.285" Thick)	Pear	4-1/4 x 5-1/4	3/8
PB9474	Obround	4-1/8 x 4-7/8	3/16	Oval	Oval	3-1/2 x 4-1/2	3/8
PB9474	Round	3-1/2	3/16	Oval	Oval	3 x 4	3/8
Connelly	Obround	3 x 3-15/16	3/8	Vogt	Oval	3 x 4	5/16
Edge Moor	Oval	4-1/8 x 5-1/4	3/8	Oval	Oval	3-3/8 x 4-1/4	7/32
	Round	2-1/2	1/2	Oval	Oval	3-1/4 x 4-1/2	5/16
	Round	4-1/16	15/32	Oval	Oval	3-3/4 x 5	3/8
Erie City	Pear	3-1/2 x 4-5/8	3/8	Oval	Oval	4 x 5	5/16
	Obround	3 x 4-1/2	3/8	Oval	Oval	4 x 6	3/8
	Oval	3-1/32 x 4-1/32	5/16	Oval	Oval	4-1/4 x 5-1/8	7/32 (new)
	Oval	3-17/32 x 4-17/32	5/16	Oval	Oval	4-1/4 x 5-1/8	5/16 (old)
	Oval	4-1/32 x 5-1/32	5/16	Oval	Oval	4-9/32 X 5-5/32	7/32
	Oval	4-1/32 x 6-1/32	3/8	31/2"	Round	3-19/32	3/8
	Round	3-1/2	3/8	Round	Round	4-1/8	3/8
Foster Wheeler	Diamond	4 x 5	3/8	Ward	Square	4-7/8 x 4-7/8	1/4
23/4"	Obround	2-25/32 x 3-13/32	7/32	Wickes	Pear	4-1/8 x 5-1/8	9/32
	Obround	3 x 4	3/8	Pear	Pear	4-1/4 x 5-1/8	3/8
	Obround	3-11/32 x 3-31/32	7/32	Oval	Oval	3 x 4	5/16
	Oval	4-3/16 x 5-3/16	5/16	D2300	Oval	3-1/2 x 4-1/2	5/16
	Round	15/16	5/32	D2361	Oval	4 x 5	5/16
	Round	2-1/32	13/64	D2724	Oval	4 x 6	5/16
	Round	2-1/32	15/64	Round	Round	4-1/8	3/8
	Round	2-1/8 or 2-1/16	3/8	Round	Round	4-1/4	3/8



SELF-LOCATOR GASKETS

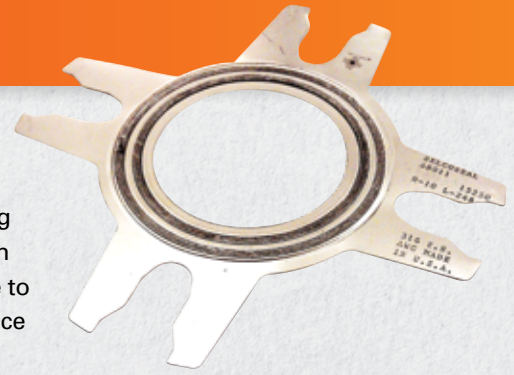

US NAVY "HYBRID"

The SELF LOCATOR gaskets are a complete stainless steel containment of a sealing element offering a true compression seal. The patented design gives you long term reliability without flange welding and eliminates misalignment on installation. Due to its universal sizing, one gasket fits all flange pressure classes, eliminating the chance of incorrect gasket selection. The most important feature of the gasket is the high unit load generated by the narrow sealing area provides a considerably higher flange clamping pressure and a better seal at a lower clamping force. The standard gasket material is 316 SS, with two (2) tracks of Flexible Graphite sealing elements. Specialty gasket material and/or sealing elements are available as options.

TECHNICAL DATA

SIZES	½, ¾, 1, 1¼, 1½, 2, 2½, 3, 3½, 4, 5, 6, 8, 10, 12, 14, 16, 18, 20, 22, 24
FLANGE PRESSURE CLASS	150# to 2500#
THICKNESS	1/32" thru 12" 1/16" above 12"
TORQUE VALUES	50% to 65% of Bolt Yield
FLANGE SURFACE FINISH	10 to 400 µin RMS (microinches)
SEALING ELEMENTS WIDTH	≥1½ (gasket size) 0.125" each side ½ to 1¼ (gasket size) 0.100" each side
MIN. SEALING ELEMENT WEB WIDTH	0.670"
"M" AND "Y" VALUES	m = 2.85 Y = 2900 psi
LEAK RATE	0.005 in mg/m*s (DIN 28090 / 1.2) < 10ppm @ He
TEMPERATURE RANGE	-200°C cryogenic air +500°C in regular atmosphere +650°C in steam +1000°C reducing or inert media
PRESSURE RANGE	Full vacuum to +5000 PSI
MIN. SEATING STRESS	2900 PSI (20 MPa) 23,200 psi (160 MPa) (testing equipment limit)
RECOMMENDED SEATING STRESS	5800 to 8700 psi (40 to 60 MPa)
STANDARDS AVAILABLE	ANSI 16.5, DIN 2600, JIS B2220, BS 4505, BS 10, AUS 2129

KEY BENEFITS

- Ability to cope against severe thermal cycling and vibration
- Inherent Live Loading capability
- Fire, Blow Out and Leak proof
- Superior pressure handling
- Standardize: one gasket for all pressure classes
- Protects against use of wrong gasket
- Lowers total sealing costs
- Cannot be over compressed
- No need to re-torque
- Eliminates fugitive emissions
- US Navy approved
- ANSI, DIN, JIS, BS and AUS sizes available

* RAGCO supports the autonomy of its locations to select the best products to service their markets. Subtle variations of these specification may exist. Contact your RAGCO affiliate for confirmation.

TOPOG-E® GASKETS



The steam boiler market makes extreme demands on gaskets; Topog-E® molded rubber gaskets are specifically formulated to meet and exceed these demands and deliver industry standard performance.

Topog-E® Series 180 gaskets have been refined through a series of over 600 research formulation tests to ensure that they are able to meet the exacting performance standards of the steam boiler industry.

Specifically they:

1. Conform to the topography of the mating surfaces
2. Withstand a boiler's full, continuous and cycling operating pressures
3. Withstand continuous exposure to water treatment chemicals
4. Withstand continuous exposure to ion and oxygen attack in hot air
5. Prevent all leakage
6. Replace easily, without chiselling or buffing

MATERIALS

Special, proprietary rubber Composition, black, 80-85 Durometer.

SERVICE SUMMARY

Steam boilers: up to 180 psi (12 bar) and 380° F. (193° C) Water, condensate, etc. vessels: 200+ psi (14 bar) and less than 300°F. (150°C)

APPLICATIONS

When used on steam pressure vessels Topog-E® Series 180 gaskets are typically used at operating pressures of up to 180 PSI (12 bar) and saturated steam temperatures up to 380° F. (193° C) for an average service life of one year. When used in other applications (e.g. condensate, water, and air vessels) Topog-E® Series 180 gaskets are sometimes used at pressures above 200 PSI (14 bar) where temperatures are typically more moderate (e.g. below 250°F./121°C.). When operating under less severe conditions (e.g. water applications at ambient temperatures) Topog-E® Series 180 gaskets can provide very long service lives. Topog-E® Series 180 gaskets have been used successfully around the world for over forty years. In general, any type of industrial pressure vessel or tank that has inspection openings is a potential application where Topog-E® Series 180 gaskets can be used as a cost effective sealing device.

In addition to using them in steam pressure vessels, customers also use Topog-E® molded gaskets and sheet material with great success in many other applications, including:

- Water softeners
- Hot water heaters
- Steam humidifiers and cookers
- Water purifiers and demineralizers
- Refrigeration units
- Liquid treatment vessels
- Carbon absorption and filtering vessels
- Dryer cans in paper mills
- Water hydrants
- Mixing tanks
- Compressed air tanks
- Various types of dryers
- Air starters and receivers
- Deaerators
- Hatch covers
- Water towers and columns
- PVC reactor vessels

INSTALLATION ENVIRONMENT & SUITABILITY

Topog-E® Series 180 gaskets are specifically formulated to have excellent resistance to steam and hot and cold water.

They also have good resistance to:

- Alcohols
- Ketones
- Phosphate esters
- Silicone oils and greases
- Dilute acids
- Bases
- Salts
- Glycols
- Ammonia
- Selected refrigerants
- Animal and vegetable fats

Water treatment chemicals, when used in accordance with supplier's guidelines, should not have a significant effect on the service life of properly installed Topog-E® Series 180 gaskets.

Topog-E® Series 180 gaskets are not recommended for use in applications where they see direct exposure to high concentrations of aromatic hydrocarbons, chlorinated solvents, or petroleum based oils, fuels, and lubricants.

TOPOG-E® GASKET SIZES

When ordering, be sure to state the two inside dimensions (A & B), flange width (C), thickness (D), and shape (E, OB, etc.).

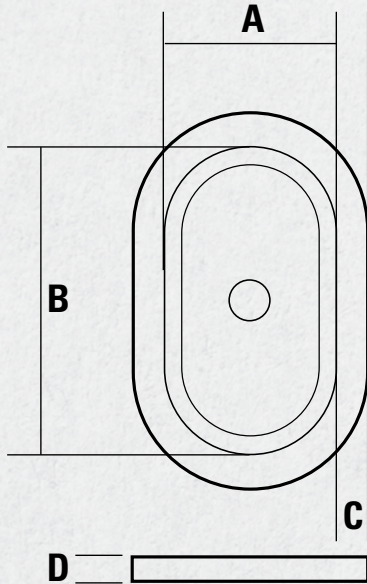

SHAPE CODE



Elliptical – E



Pear – P



OB Round – OB



Square – S



Round – R



Special Square – SPS

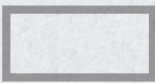

Rectangle – Rect.



Elliptical Turtle – ET



Diamond – D

SIZE (IN)				SHAPE CODE	TYPE
A	B	C	D		
(unless stated otherwise)					
Elliptical - 'E'					
1-7/8	2-1/2	7/16	-	E	Handhole
1-3/4	3-3/4	3/8	-	E	Handhole
2	3	3/8	-	E	Handhole
2-1/4	3-1/4	1/2	-	E	Handhole
2-1/4	3-3/4	1/2	-	E	Handhole
2-1/2	3-1/4	3/8	-	E	Handhole
2-1/2	3-1/2	1/2	-	E	Handhole
2-3/4	3-1/2	3/8	3/16	E	Handhole
2-1/2	3-3/4	3/8	3/16	E	Bracket
2-3/4	3-1/2	1/2	-	E	Handhole
2-1/2	3-3/4	1/2	-	E	Bracket
2-3/4	3-3/4	5/8	-	E	Handhole
2-3/4	3-3/4	1/2	-	E	Handhole
2-7/8	3-7/8	1/2	-	E	Handhole
3	3-3/4	1/2	-	E	Handhole
2-3/4	4-1/2	5/8	-	E	Handhole
3	4-1/4	5/8	-	E	Bracket
3	4	5/16	-	E	Handhole
3	4	1/2	-	E	Handhole
2-3/4	4-1/4	1/2	-	E	Bracket
3	4	5/8	-	E	Handhole
3	4	3/4	-	E	Handhole
3	4	1-1/2	-	E	Handhole
3	4-1/2	1/2	-	E	Handhole
3	4-1/2	5/8	-	E	Handhole
3	5	9/16	-	E	Handhole
3-1/4	4-3/4	9/16	-	E	Bracket
3-1/4	4-1/4	1/2	-	E	Handhole
3-1/4	4-1/4	3/4	-	E	Handhole
3	4-1/2	3/4	-	E	Bracket
3-1/4	4-1/2	1/2	-	E	Handhole
3-1/4	5	9/16	-	E	Handhole
3-3/8	4-3/8	7/16	-	E	Handhole
3-3/8	4-3/8	9/16	-	E	Handhole
3-1/2	4-1/2	7/16	-	E	Handhole
3-1/2	4-1/2	1/2	-	E	Handhole
3-1/2	4-1/2	5/8	-	E	Handhole
3-1/2	4-1/2	3/4	-	E	Handhole
3-1/2	4-1/2	1-1/2	-	E	Handhole
3-1/2	5	1/2	-	E	Handhole
3-1/2	5	3/4	-	E	Handhole
3-3/4	4-3/4	9/16	-	E	Handhole
3-3/4	5-1/2	9/16	-	E	Handhole
4	5-1/4	9/16	-	E	Bracket
4	5	5/8	-	E	Handhole
3-3/4	5-1/4	5/8	-	E	Bracket

SIZE (IN)				SHAPE CODE	TYPE
A	B	C	D		
(unless stated otherwise)					
3-1/2	5-1/2	5/8	-	E	Bracket
4	4-3/8	1/2	-	E	Handhole
4	5-1/2	3/4	-	E	Handhole
4-1/2	5-1/2	5/8	-	E	Handhole
4	6	5/8	-	E	Handhole
4-1/2	6	3/4	-	E	Handhole
4-1/4	5-1/8	3/8	-	E	Handhole
4-1/2	6-1/2	9/16	-	E	Handhole
4-1/2	6-1/2	1-1/4	-	E	Handhole
4-3/4	6-5/8	3/4	-	E	Handhole
5	6	5/8	-	E	Handhole
5	7	3/4	-	E	Handhole
5-3/4	7-1/4	3/4	-	E	Handhole
6	8	3/4	-	E	Handhole
6	8	1	-	E	Handhole
6	9	1	-	E	Handhole
6	10	5/8	-	E	Handhole
6	10	1	-	E	Handhole
7	9	3/4	-	E	Handhole
7	10	1-1/2	-	E	Handhole
7-1/2	10-1/4	3/4	-	E	Handhole
7-1/2	11-1/2	1	-	E	Manway
7-7/8	11-3/4	1	-	E	Manway
8	10	1	-	E	Manway
8-5/8	12-1/2	1	-	E	Manway
8	11	1	-	E	Manway
9	12	1	-	E	Manway
9	14	1-1/4	-	E	Manway
9-1/2	14	1-1/8	-	E	Manway
9-3/4	14-1/2	2	-	E	Manway
9-3/4	14-3/4	1-1/4	-	E	Manway
9-1/2	15-1/2	1	-	E	Manway
9-15/16	15-15/16	3/4	-	E	Manway
10	14	1	-	E	Manway
10	14	1-1/2	-	E	Manway
10-1/2	14	1-1/4	-	E	Manway
10-1/2	14-1/2	1-1/4	-	E	Manway
10-1/2	14-1/2	1-3/8	-	E	Manway
10	15	1-3/8	-	E	Bracket
10-1/2	15	1-1/4	-	E	Manway
10-1/2	14-1/2	1-3/4	-	E	Manway
10-3/4	14-3/4	1-1/4	-	E	Manway
10	16	5/8	-	E	Manway
11	14	1-3/8	-	E	Manway
11	14	1-1/4	-	E	Manway
11	14-1/2	1	-	E	Manway

SIZE (IN)				SHAPE CODE	TYPE
A	B	C	D		
(unless stated otherwise)					
11	14-3/4	1-1/2	-	E	Manway
11-1/2	14-1/2	1-1/4	-	E	Manway
11	15	3/4	-	E	Manway
11	15	1	3/16	E	Manway
11	15	1	-	E	Manway
11	15	1-1/4	-	E	Manway
11	15	1-3/8	-	E	Manway
11	15	1-3/4	-	E	Manway
11-1/2	15-1/2	1-1/4	-	E	Manway
11-1/2	15-1/2	1-3/4	-	E	Manway
11-3/4	15-3/4	1-3/8	-	E	Manway
11-3/4	15-3/4	1-3/4	-	E	Manway
11	16	1-1/4	-	E	Manway
12	15	1	-	E	Manway
12	15	1-1/4	-	E	Manway
12	15-1/2	1	-	E	Manway
12	15-1/2	1-1/4	-	E	Manway
12	16	1	-	E	Manway
12	16	1-1/4	-	E	Manway
12	16	1-3/8	-	E	Manway
12-1/2	16-1/4	1-1/4	-	E	Manway
12-1/2	16-1/2	1	-	E	Manway
14	18	1-1/2	-	E	Manway
18	24	1-1/2	-	E	Manway
OBround - 'OB' flat sides					
1-3/4	3-3/4	1/2	-	OB	Handhole
2	3	1/2	-	OB	Handhole
2-1/4	3-1/4	1/2	-	OB	Handhole
2-1/4	3-1/4	3/8	-	OB	Handhole
2-1/2	3-1/2	1/2	-	OB	Handhole
2-1/4	3-3/4	9/16	-	OB	Handhole
2	4	9/16	-	OB	Bracket
2-1/2	3-3/4	1/2	3/16	OB	Handhole
2-3/4	3-1/2	1/2	-	OB	Handhole
2-3/4	3-3/4	1/2	-	OB	Handhole
2-7/8	3-7/8	7/16	-	OB	Handhole
2-7/8	4-3/8	9/16	-	OB	Handhole
2-3/4	4-1/2	1/2	-	OB	Handhole
3	4-1/4	1/2	-	OB	Bracket
2-3/4	4-3/4	1/2	-	OB	Handhole
3	4	1/2	-	OB	Handhole
3	4	9/16	-	OB	Handhole
3	4-1/2	9/16	-	OB	Handhole
3-1/4	4-1/4	9/16	-	OB	Handhole
3	5	9/16	-	OB	Handhole
3-1/4	4-1/2	1/2	-	OB	Handhole

* RAGCO supports the autonomy of its locations to select the best products to service their markets. Subtle variations of these specification may exist. Contact your RAGCO affiliate for confirmation.



TOPOG-E® GASKET SIZES

SIZE (IN)				SHAPE CODE	TYPE
A	B	C	D		
(unless stated otherwise)					
3-1/4	4-1/2	9/16	-	OB	Handhole
3-1/4	4-3/4	5/8	-	OB	Handhole
3-1/4	4-3/4	1/2	-	OB	Handhole
3-1/2	4-1/2	9/16	-	OB	Handhole
3	4-3/4	9/16	-	OB	Bracket
3-3/8	4-1/4	3/8	-	OB	Handhole
3-1/2	5	9/16	-	OB	Handhole
3-1/4	5-1/4	9/16	-	OB	Bracket
3-1/2	5-1/2	1/2	-	OB	Handhole
3-1/2	5-1/2	5/8	-	OB	Handhole
3-5/8	5-5/8	7/16	-	OB	Handhole
3-5/8	5-5/8	9/16	-	OB	Handhole
3-5/8	5-5/8	1	-	OB	Handhole
4	5	5/8	-	OB	Handhole
4-1/2	5-1/2	5/8	-	OB	Handhole
4	6	5/8	-	OB	Handhole
4-1/2	6	5/8	-	OB	Handhole
4-1/2	6-1/2	5/8	-	OB	Handhole
4-1/2	10-1/4	3/4	-	OB	Handhole
5	6-3/4	1	-	OB	Handhole
5	7	5/8	-	OB	Handhole
5	7-1/2	1	-	OB	Manway
10-1/2	14-1/2	1-5/16	-	OB	Manway
11	15	1-1/4	-	OB	Manway
12	16	1-1/2	-	OB	Manway
Round 'R'					
Inner 'D'	Outer 'D'	C	D		
1-3/8	2-5/16	-	5/16	R	Handhole
2-7/8	3-5/8	-	1/8	R	Handhole
2-15/16	3-15/16	-	-	R	Handhole
3	3-5/8	-	3/16	R	Handhole
3	3-3/4	-	-	R	Handhole
3	4	-	-	R	Handhole
3-1/4	4	-	-	R	Handhole
3-1/2	4-3/16	-	3/16	R	Handhole
3-1/2	4-1/2	-	-	R	Handhole
3-1/2	5	-	-	R	Handhole
3-1/2	5-1/2	-	-	R	Handhole
3-11/16	4-1/2	-	3/8	R	Handhole
4	4-3/4	-	-	R	Handhole
4	5	-	-	R	Handhole
4	5-1/4	-	3/16	R	Handhole
4-1/4	5-1/16	-	-	R	Handhole
4-1/2	5-1/2	-	3/16	R	Handhole
4-3/4	6-3/8	-	-	R	Handhole
5	6	-	-	R	Handhole

SIZE (IN)				SHAPE CODE	TYPE
Inner 'D'	Outer 'D'	C	D		
(unless stated otherwise)					
5-1/4	8	-	5/16	R	Handhole
5-7/16	7-9/16	-	5/16	R	Handhole
6	7-1/2	-	-	R	Handhole
10-3/4	13-3/8	-	1/8	R	Handhole
12-3/4	16-1/8	-	1/8	R	Handhole
Special Shapes					
1-1/2	3-3/4	-	-	R, 4 Holes	Flange
2	3-1/2	-	-	S, 4 Holes	Flange
7-3/8	7-3/8	5/8	-	S	Handhole
2	6	1-1/2	-	Rect.	Handhole
2-13/16	16-7/8	1-1/16	3/16	Rect.	Handhole
3-3/4	8-1/2	1/2	-	Rect.	Handhole
4-1/2	6	1/4	-	Rect.	Handhole
6-1/4	9-3/4	5/8	-	Rect.	Handhole
3	4	9/16	-	K	Handhole
3-3/8	3-3/4	1/4	1/8	D	
3-3/8	4-1/4	1/4	-	D	Handhole
3-1/2	4-1/2	1/4	-	D	Handhole
4	5	1/2	-	D	Handhole
4-1/4	5-1/4	13/32	-	D	Handhole
3-1/2	4-1/2	7/16	-	P	Handhole
3-3/8	4-3/8	1/2	-	P	Handhole
3-5/8	4-3/4	1/2	-	P	Handhole
4	5	1/2	-	P	Handhole
4	5	9/16	-	N.P.	Handhole
4	5	5/8	-	W.P.	Handhole
4-1/4	5-1/8	1/2	-	SPU.P	Handhole
5-1/4	5-1/4	3/8	-	SPS	Handhole
7-7/16	7-7/16	9/16	-	SPS	Handhole
10	16	1-3/4	-	ET	Manway
8-3/4	14	2-1/4	-	E, w 4 Bolt Holes	Manway
3-7/8	13-3/8	1-3/16	1/8	OB	Flange

DISCLAIMER All information in this data sheet is based on data believed to be reliable, however we make no guarantee or warranty of performance of Topog-E® Series 180 gaskets. Because there are many application-specific factors that can affect service life it is always advisable to first test Topog-E® Series 180 gaskets in a particular application to determine their ultimate suitability.



NOTES

- Standard thickness is 1/4" unless otherwise noted under column D.
- All prices are for Topog-E® Gasket Standard Material (refer to separate Material Specification sheet for more information).
- Prices are F.O.B. Tulsa, Oklahoma 74110.
- Bracketed gaskets are not stock molded sizes, however, the first stock size can often be used on plates designed for the bracketed size.
- A 25% restocking fee may be charged on all returns.
- Special sizes and shapes can be fabricated upon request.
- Topog-E® gaskets can be made from other materials – contact us to receive a Materials Specification Sheet for Alternative Elastomeric Materials.
- We also make chemical tank and water hydrant gaskets.

DISCLAIMER Topog-E® gaskets are made and sold for use in steam, water, air, and other selected applications only. Our recommendations for their use are based on tests believed to be reliable and on actual customer experience. Since their installation and use are beyond our control, we cannot guarantee the results, whether or not such use is in accordance with instructions. We disclaim any responsibility.

STYLE 921



Style 921 is braided from a long lasting blend of Flax and Ramie fibers, than thoroughly lubricated with a proprietary Tallow and Wax blend. A low friction, economical, general service packing used extensively on shipboard applications for stern tubes, rudderposts, and water pumps. This packing is especially resistant to cold water, seawater, and cold oils, but is also used in a variety of other applications in the pulp and paper, marine, and wastewater industries.

CONSTRUCTION	Plait Braid	SHAFT SPEED RAFTING	1200 FPM / 6 MPS
TEMPERATURE RATING	220°F / 104°C	PRESSURE RATING	150 PSI / 10 BAR
PH RATING	5 - 9	INDUSTRY CROSSOVER	528, 80, 863, 18, 2, 2138, 200

STYLE 3000G



Braided from continuous Acrylic blended fiber, Style 3000G is impregnated with our proprietary high temperature lubricant, and pre and post lubricated with high purity graphite flake. Our unique lubrication process insures a dense but flexible general service packing, which can be used in most steam, water, salt water, oil, and mild acid or alkali applications.

CONSTRUCTION	Interlock Braid	SHAFT SPEED RAFTING	1500 FPM / 8 MPS
TEMPERATURE RATING	500°F / 260°C	PRESSURE RATING	300 PSI / 20 BAR
PH RATING	4 - 10	INDUSTRY CROSSOVER	1398, 1430, 1315, 1340, 8913, PM2, ML402, 2255, 236

SYTLE 3000T

Braided from continuous Acrylic blended fiber, Style 3000T is impregnated with PTFE and a proprietary inert lubricant. Style 3000T packing is also a non-staining and non-contaminating packing with excellent heat dissipation properties. A durable and resilient packing for general service applications such as centrifugal, rotary, and reciprocating pumps, as well as valve service. Our proprietary lubricant is used for extremely low friction at startup and during operation.



CONSTRUCTION	Interlock Braid	SHAFT SPEED RAFTING	2500 FPM / 12 MPS
TEMPERATURE RATING	500°F / 260°C	PRESSURE RATING	500 PSI / 34 BAR
PH RATING	0 – 12	INDUSTRY CROSSOVER	1152, 412-W, 1774, 1335, 8922, PM1, ML2225, 2019, 237

SYTLE 300

Braided from continuous Aramid filament, Style 300 is impregnated with PTFE and a proprietary inert lubricant. Our unique braiding technique makes our Style 300 easy to cut and install, with excellent braid retention. Style 300 is also non-staining and non-contaminating packing with excellent heat dissipation properties. The high tensile strength of Aramid fiber makes this packing ideally suited for slurry or any abrasive service where media is extremely aggressive.



CONSTRUCTION	Interlock Braid	SHAFT SPEED RAFTING	2500 FPM / 12 MPS
TEMPERATURE RATING	500°F / 260°C	PRESSURE RATING	500 PSI / 34 BAR
PH RATING	2 – 12	INDUSTRY CROSSOVER	170, 1740, K1730, 5200, PM5, ML4800, 2004, 213

* RAGCO supports the autonomy of its locations to select the best products to service their markets. Subtle variations of these specification may exist. Contact your RAGCO affiliate for confirmation.

STYLE 344



Braided from 100% PTFE filament, Style 344 is then thoroughly impregnated with a PTFE suspensoidal blocking agent. With no sacrificial lubricants to wear out, Style 344 is long lasting, with an extremely low coefficient of friction and excellent heat dispersion. Ideally suited for chemical process applications where extreme chemical resistance is required

CONSTRUCTION	Interlock Braid	SHAFT SPEED RAFTING	N/A
TEMPERATURE RATING	500°F / 260°C	PRESSURE RATING	2000 PSI / 138 BAR Static
PH RATING	0 – 14	INDUSTRY CROSSOVER	154, 324, 1724, C1045, 5888, PM7, ML2254, 2005, 232

STYLE 344BIL



Braided from 100% PTFE filament, Style 344BIL is thoroughly impregnated with a PTFE suspensoidal blocking agent and our proprietary break in lube. Our unique blend of lubricating oil eases friction during startup and operation. A soft but dense and stable packing, 344BIL is ideally suited for chemical process pumps where extreme chemical resistance and extremely low shaft friction are required.

CONSTRUCTION	Interlock Braid	SHAFT SPEED RAFTING	1500 FPM / 8 MPS
TEMPERATURE RATING	500°F / 260°C	PRESSURE RATING	300 PSI / 20 BAR
PH RATING	0 – 14	INDUSTRY CROSSOVER	154-S, 328, 1728, C1050, 5889, PM8, ML2235, 2006, 231

SYTLE 344FDA

Braided from continuous 100% Teflon Fiber that satisfies all FDA requirements. For all applications in the food processing industry or anywhere FDA material is required in pumps or valves. Style 344FDA is in full compliance with the FDA and USDA requirements under Title 21 Food and Drugs, 178.3570, Lubricants with Incidental Food Contact, and 177.1550, Perfluorocarbon Resins. Style 344FDA contains only material permitted for food contact use by the U.S. Department of Agriculture and the Food and Drug Administration.

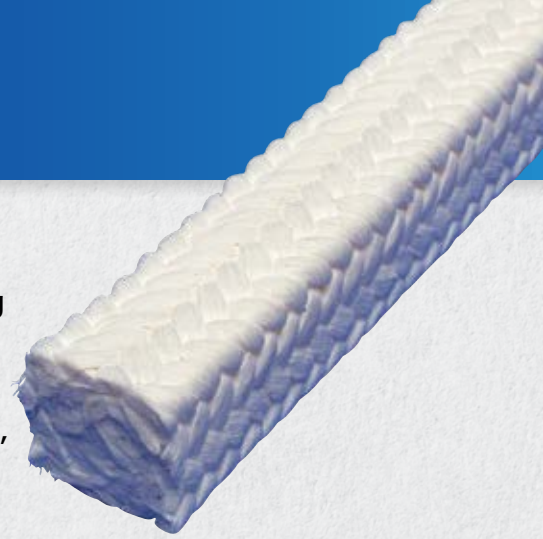

CONSTRUCTION	Interlock Braid	SHAFT SPEED RAFTING	1500 FPM / 8 MPS
TEMPERATURE RATING	500°F / 260°C	PRESSURE RATING	300 PSI / 20 BAR
PH RATING	0 – 14	INDUSTRY CROSSOVER	154FDA, 1725, C1056, 5904, ML2236, 2006FDA, 245

SYTLE 345

Braided from our proprietary blend of high quality flax and ramie yarns, Style 345 is thoroughly impregnated with PTFE and our proprietary inert lubricant. Our unique braiding technique and deep PTFE impregnation makes our Style 345 easy to cut and install, with excellent braid retention and conformability. Style 345 is also long lasting, corrosion resistant, and ideally suited for use in most saltwater/freshwater applications.



CONSTRUCTION	Plait Braid	SHAFT SPEED RAFTING	1200 FPM / 6 MPS
TEMPERATURE RATING	250°F / 121°C	PRESSURE RATING	200 PSI / 14 BAR
PH RATING	5 – 9	INDUSTRY CROSSOVER	525-T, 329, 867, 5413, 219, 2421, 201

* RAGCO supports the autonomy of its locations to select the best products to service their markets. Subtle variations of these specification may exist. Contact your RAGCO affiliate for confirmation.

STYLE 3030INA



Braided from Inconel® wire inserted fiberglass over a proprietary core, and surface coated with our graphite blend, Style 3030INA is an economical substitute for more expensive steam packing. Style 3030INA packing also contains a corrosion inhibitor to internally protect the valve from oxidation. For use as a high temperature and pressure valve stem or expansion joint packing.

CONSTRUCTION	Braid over Core	SHAFT SPEED RAFTING	N/A
TEMPERATURE RATING	1200°F / 649°C	PRESSURE RATING	3000 PSI / 206 BAR Static
PH RATING	2 – 13	INDUSTRY CROSSOVER	1414, 1800, 287-I, 387-I, 127AFP, ML310, 2214, 683

STYLE 4000



Braided from a blend of carbon yarns, Style 4000 is impregnated with a proprietary blocking agent. Designed to be highly durable and easy to install, Style 4000 packing is also a non-staining, self-lubricating packing. Our unique blend of Carbon yarns ensures extremely low shaft wear, while maintaining excellent heat dissipation. Typically used for severely caustic or corrosive media, this packing is suited for almost any high speed/high temperature pump or valve.

CONSTRUCTION	Interlock Braid	SHAFT SPEED RAFTING	3000 FPM / 15 MPS
TEMPERATURE RATING	600° F / 315°C	PRESSURE RATING	500 PSI / 34 BAR Pump 3600 PSI / 250 BAR Valve
PH RATING	0 – 14	INDUSTRY CROSSOVER	50, 1738, 1655CF, 5000/105, ML4461, 2103, 228

STYLE 4000G

Braided from a blend of carbon yarns, Style 4000G is impregnated with a proprietary blocking agent, and high purity graphite flake. Designed to be highly durable and easy to install, Style 4000G packing is also a low leakage, self-lubricating packing. Our unique blend of Carbon yarns ensures extremely low shaft wear, while maintaining excellent heat dissipation. Typically used for severely caustic or corrosive media, this packing is suited for almost any high speed/high temperature pump or valve.



CONSTRUCTION	Interlock Braid		SHAFT SPEED RAFTING	4000 FPM / 20 MPS
TEMPERATURE RATING	850° F / 455°C	Air	PRESSURE RATING	500 PSI / 34 BAR Pump
	1200° F / 649°C	Steam		4350 PSI / 296 BAR Valve
	6000° F / 3315°C	Non-Oxidizing Atmosphere		
PH RATING	0 – 14		INDUSTRY CROSSOVER	90, 370, 477-1, 1650CF, 98/108, ML4460, 2002, 226

SYTLE 5000

Braided from high purity graphite yarns, Style 5000 is designed to be virtually leak free. Under gland pressure, Style 5000 forms a homogenous mass, resulting in maximum sealability, and reducing flush water usage. Style 5000 packing is also a low friction, self-lubricating packing, with extremely low friction, and excellent heat dissipation. Typically used for high temperature pump or valve applications.



CONSTRUCTION	Plait Braid		SHAFT SPEED RAFTING	4000 FPM / 20 MPS
TEMPERATURE RATING	850° F / 455°C	Air	PRESSURE RATING	500 PSI / 34 BAR Pump
	1200° F / 649°C	Steam		3000 PSI / 207 BAR Valve
	6000° F / 3315°C	Non-Oxidizing Atmosphere		
PH RATING	0 – 14		INDUSTRY CROSSOVER	1100TCP, 1400, 1656G/ G58, 1300, ML2001, ML911, 2000, 686

* RAGCO supports the autonomy of its locations to select the best products to service their markets. Subtle variations of these specification may exist. Contact your RAGCO affiliate for confirmation.

STYLE 5000IJ



Braided from Inconel® jacketed, 98% purity flexible graphite, Style 5000IJ is ideally suited for extremely high temperature and pressure valve service applications. Our unique reinforcement and densification process exceeds API 622 2nd Ed test standards, and is an ideal solution for containment of fugitive emissions at below 5 PPMv average leakage. Style 5000IJ is non-scoring and self-lubricating, with a unique combination of Corrosion Inhibitors. An excellent choice for Leak Detection and Repair (LDAR) programs.

CONSTRUCTION	Plait Braid		SHAFT SPEED RAFTING	N / A
TEMPERATURE RATING	850° F / 455°C	Air	PRESSURE RATING	6500 PSI / 448 BAR
	1200° F / 649°C	Steam		
	2000° F / 1100°C	Non-Oxidizing Atmosphere		
PH RATING	0 – 14		INDUSTRY CROSSOVER	1600, 1303FEP, 2235

STYLE 8000LC



Braided from industrial grade graphite filament, 8000LC is an economical substitute for most braided carbon packing. Coated with our proprietary graphite blend, 8000LC has a low coefficient of friction, as well as extremely high thermal conductivity. For use in valves, centrifugal pumps, rotary pumps, and reciprocating pumps, where the media is highly aggressive or where a high speed shaft packing is needed.

CONSTRUCTION	Interlock Braid		SHAFT SPEED RAFTING	4000 FPM / 20 MPS
TEMPERATURE RATING	850° F / 455°C	Air	PRESSURE RATING	500 PSI / 34 BAR Pump 4000 PSI / 276 BAR Valve
	1200° F / 649°C	Steam		
	6000° F / 3155°C	Non-Oxidizing Atmosphere		
PH RATING	0 – 14		INDUSTRY CROSSOVER	160, 1-2, 1630G, G700, ML4444, 2001

STYLE 8000T

Braided from 100% genuine GFO® fiber, a filament yarn made from finely ground particles of high quality graphite encapsulated in a Teflon® matrix to eliminate graphite migration. For use in valves, centrifugal pumps, rotary pumps, reciprocating pumps, this packing combines the heat dissipation properties of Graphite, with the chemical resistance of Teflon®.



CONSTRUCTION	Interlock Braid	SHAFT SPEED RAFTING	4300 FPM / 21 MPS
TEMPERATURE RATING	550° F / 290°C	PRESSURE RATING	300 PSI / 20 BAR Pump 2000 PSI / 38 BAR Valve
PH RATING	0 – 14	INDUSTRY CROSSOVER	165, 5100, ML4002

SYTLE 8200BIL

Braided from Lubricated PTFE/Graphite filaments, Style 8200BIL is an economical alternative to most PTFE/Graphite packing. Style 8200BIL is a self-lubricating, low friction packing suitable for most general service applications. Our proprietary break in lubricant ensures low shaft wear, while maintaining good packing to shaft contact. Style 8200BIL has the high heat dissipating qualities of Graphite, with the added chemical resistance of PTFE.



CONSTRUCTION	Interlock Braid	SHAFT SPEED RAFTING	4000 FPM / 20 MPS
TEMPERATURE RATING	550° F / 287°C	PRESSURE RATING	300 PSI / 20 BAR Pump 2000 PSI / 138 BAR Valve
PH RATING	0 – 14	INDUSTRY CROSSOVER	165LA, 1750, C1065, PM6, ML3600, 2007

* RAGCO supports the autonomy of its locations to select the best products to service their markets. Subtle variations of these specification may exist. Contact your RAGCO affiliate for confirmation.



NITRILE O-RING OVERVIEW (Buna N)

MATERIAL: Butadiene Acrylonitrile Copolymer (Nitrile Rubber, NBR)

MATERIAL DESCRIPTION

Nitrile rubber (NBR), also known as Buna N, is one of the most commonly used sealing elastomers due to its resistance to petroleum based fuels and lubricants and its relatively low price. Nitrile elastomers are copolymers of acrylonitrile and butadiene. There are a number of common variations of nitrile compounds.

ACRYLONITRILE CONTENT

The acrylonitrile (ACN) content of the polymer chains can vary from 18% to 50%. Lower ACN content gives better low temperature properties but inferior resistance to fuels and polar lubricants. Higher ACN content gives lesser quality low temperature properties but improved fuels and polar lubricants resistance. Standard NBRs typically have 34% ACN content.

CURE SYSTEM: SULFUR-CURED

Standard Nitriles are usually sulfur cured. Sulfur cured compounds offer better low temperature properties but are more prone to hardening with high temperatures. Peroxide cured nitriles have better heat resistance and lower compression sets but are more expensive and more difficult to process.

NITRILE O-RING OVERVIEW (Buna N) continued

OTHER COMMON VARIATIONS

- Nitriles often are internally lubricated to improve ease of installation or reduce friction for dynamic applications.
- Nitriles can be formulated with only “white list” ingredients, as specified in 21.CFR 177.2600, for use in applications where the elastomer will be in contact with food or beverages.
- Nitriles can be submitted for approval by the National Sanitation Foundation (NSF) for use in drinking water applications.
- Nitriles can also be submitted for approval to Underwriters Laboratories (UL) for use in applications as prescribed in UL 157.
- Nitrile rubber can be combined with polyvinyl chloride (PVC) to create fuel, ozone and weathering resistance NBR PVC blends.

GENERAL INFORMATION

ASTM D1418 DESIGNATION	NBR	STANDARD COLOR	Black
ISO/DIN 1629 DESIGNATION	NBR	HARDNESS RANGE	40 to 90 Shore A
ASTM D2000/ SAE J 200 CODES	BF, BG, BK, CH	RELATIVE COST	Low

SERVICE TEMPERATURES

STANDARD LOW TEMPERATURE	-40°F -40°C	SPECIAL COMPOUND LOW TEMPERATURE	-67°F -55°C
STANDARD HIGH TEMPERATURE	212°F 100°C	SPECIAL COMPOUND HIGH TEMPERATURE	275°F 135°C

PERFORMS WELL IN

- Petroleum based oils and fuels
- Aliphatic hydrocarbons
- Vegetable oils
- Silicone oils and greases
- Ethylene glycol
- Dilute acids
- Water to below 100°C (212°F)

DOESN'T PERFORM WELL IN

- Aromatic hydrocarbons
- Automotive brake fluid
- Chlorinated hydrocarbons
- Ketones
- Ethers
- Esters
- Phosphate ester hydraulic fluids
- Strong acids
- Ozone/weathering/sunlight

NITRILE-70 O-RING (Buna-70)

TEST REPORT FOR COMPOUND N70

DUROMETER: 70

COLOR: BLACK

ASTM* D2000, M2BG714, A14, B14, EA14, EF11, EF21, EO14, EO34, Z1

SECTION OF SPEC.	PROPERTIES	REQUIREMENTS	RESULTS	ASTM TEST METHOD
	ORIGINAL PHYSICAL PROPERTIES			
	Hardness, Shore A	70 ± 5	70.5	D2240-05
	Tensile Strength	2031 PSI (min)	2206 PSI (15.2 MPa)	D412-06a
	Elongation	250% (min)	326%	D412-06a
	Modulus at 100%		530 PSI (3.66 MPa)	D412-06a
	Specific Gravity		1.23 g/cm ³	
	HEAT AGE: 70 hours at 100°C (212°F)			
A14	Hardness Change	± 15 points	+4 points	D573-04
	Tensile Strength Change	-20% (max)	9%	
	Elongation Change	-40% (max)	-13%	
	Weight Change	± 15%	-1%	
B14	COMPRESSION SET: 22 hours at 100°C (212°F)	25% (button) (max)	7%	D395-03, Method B
	WATER RESISTANCE: 70 hours at 100°C (212°F)			
EA14	Hardness Change	± 10 points	+1 points	D471-06
	Tensile Strength Change		+1%	
	Elongation Change		-11%	
	Volume Change	± 15%	+0.1%	
	FUEL A RESISTANCE: 70 hours at 23°C (73.4°F)			
EF11	Hardness Change	± 10 points	-1 points	D471-06
	Tensile Strength Change	-25% (max)	-3%	
	Elongation Change	-25% (max)	-6%	
	Volume Change	-5% to +10%	+0.3%	
	FUEL B RESISTANCE: 70 hours at 23°C (73.4°F)			
EF21	Hardness Change	0 to -30 points	-12 points	D471-06
	Tensile Strength Change	-60 (max)	-31%	
	Elongation Change	-60 (max)	-29%	
	Volume Change	0% to +40%	+18.9%	
	IRM 901 OIL: 70 hours at 100°C (212°F)			
EO14	Hardness Change	-5 to +10 points	+7 points	D471-06
	Tensile Strength Change	-25% (max)	5%	
	Elongation Change	-45% (max)	-21%	
	Volume Change	-10% to +5%	+9.8%	
	IRM 903 OIL: 70 hours at 100°C (212°F)			
EO34	Hardness Change	-10 to +5 points	+1 points	D471-06
	Tensile Strength Change	-45 (max)	+5%	
	Elongation Change	-45 (max)	-15%	
	Volume Change	0% to +25%	+0.6%	

*American Society for Testing and Materials



NITRILE-90 O-RING (Buna-90)

TEST REPORT FOR COMPOUND N90

DUROMETER: 90

COLOR: BLACK

ASTM* D2000, M7BG910, B14, EO14, EO34, EF11, EF21, EA14, Z1

SECTION OF SPEC.	PROPERTIES	REQUIREMENTS	RESULTS	ASTM TEST METHOD
	ORIGINAL PHYSICAL PROPERTIES			
	Hardness, Shore A	90 ± 5	87	D2240-05
	Tensile Strength	1450 PSI (min)	2499 PSI (15.2 MPa)	D412-06a
	Elongation	100% (min)	133%	D412-06a
	Modulus at 100%		1990 PSI (13.72 MPa)	D412-06a
	Specific Gravity		1.381 g/cm ³	
B14	COMPRESSION SET: 22 hours at 100°C (212°F)	25% (button) (max)	7.8%	D395-04, Method B
EA14	WATER RESISTANCE: 70 hours at 100°C (212°F)			
	Hardness Change	± 10 points	-2 points	D471-06
	Tensile Strength Change		+5%	
	Elongation Change		-11%	
	Volume Change	± 15%	+3.3%	
EF11	FUEL A RESISTANCE: 70 hours at 23°C (73.4°F)			
	Hardness Change	± 10 points	-3 points	D471-06
	Tensile Strength Change	-25% (max)	0%	
	Elongation Change	-25% (max)	-5%	
	Volume Change	-5% to +10%	+1.8%	
EF21	FUEL B RESISTANCE: 70 hours at 23°C (73.4°F)			
	Hardness Change	0 to -30 points	-14 points	D471-06
	Tensile Strength Change	-60 (max)	-28%	
	Elongation Change	-60 (max)	-30%	
	Volume Change	0% to +40%	+18.9%	
E014	IRM 901 OIL: 70 hours at 100°C (212°F)			
	Hardness Change	-5 to +5 points	+3 points	D471-06
	Tensile Strength Change	-25% (max)	-2%	
	Elongation Change	-45% (max)	-17%	
	Volume Change	-10% to +5%	-2.8%	
E034	IRM 903 OIL: 70 hours at 100°C (212°F)			
	Hardness Change	-10 to +5 points	-5 points	D471-06
	Tensile Strength Change	-45 (max)	-3%	
	Elongation Change	-45 (max)	-16%	
	Volume Change	0% to +25%	+6%	

*American Society for Testing and Materials

* RAGCO supports the autonomy of its locations to select the best products to service their markets. Subtle variations of these specification may exist. Contact your RAGCO affiliate for confirmation.

VITON® O-RING OVERVIEW

MATERIAL: Fluorocarbon Rubber

MATERIAL DESCRIPTION

Fluorocarbon is a well known high performance rubber that has excellent resistance to high temperature, ozone, weather, oxygen, mineral oil, fuels, hydraulic fluids, aromatics and many organic solvents and chemicals.

FLUORINE CONTENT

Viton® variations include: general type (A: 66% fluorine), middle fluorine content type (B, GBL: 67 to 68.5% fluorine), high fluorine content type (F, GF: 70% fluorine), improving low temperature flexibility type (GLT, GFLT) and excellent resistance to more chemicals and solvents (Viton® ETP Extreme). We also can supply excellent acid and alkali resistance parts made by VITON® TBR.

CURE SYSTEM: BISPHENOL-CURED

Standard FKM compounds are Bisphenol cured. FKM compounds with peroxide cured possess better acid solution resistance than the bisphenol cured and can replace litharge cured applied in acid solutions. In some lubricants, adding a few organic amide or amine, or choosing peroxide cured system Viton® will be better than bisphenol curing systems.

OTHER COMMON VARIATIONS

- FKM can also be submitted for approval to Underwriters Laboratories (UL) for use in applications as prescribed in UL157.
- FKM has excellent resistance to high temperature, oil, solvent, flame, chemical and weather, and is usually applied in automotive, chemical processing, aerospace and many other industries.
- Viton® GLT is broadly used in thermal range of 40°C to 250°C (40°F to 482°F) and has outstanding resistance to aggressive HTS type oils which are commonly used in aerospace industries.
- Viton® ETP is usually applied in chemical industries.
- In some fuels, adding several methanols, Viton® F and B type are more usable than A type, especially F type. If it requires lower temperature, GFLT and GBLT will be available.
- Viton® TBR 605C (TFE/propylene polymer) is better base and steam resistant than other general Viton®. It can be used in amine, amide and some bases.

GENERAL INFORMATION

ASTM D1418 DESIGNATION	FKM	STANDARD COLOR	Black
ISO/DIN 1629 DESIGNATION	FKM	HARDNESS RANGE	50 to 90 Shore A
ASTM D2000/ SAE J 200 CODES	HK	RELATIVE COST	High

SERVICE TEMPERATURES

STANDARD LOW TEMPERATURE	-15°F -26°C	SPECIAL COMPOUND LOW TEMPERATURE	-40°F -40°C
STANDARD LOW TEMPERATURE	232°F 450°C	SPECIAL COMPOUND HIGH TEMPERATURE	525°F 275°C

PERFORMS WELL IN

- Petroleum products
- Fuel or blend with methanol or ethanol
- Diesel or blend with biodiesel
- Mineral oil and grease
- Silicone oil and grease
- High vacuum
- Ozone, weather and very high temperature air
- Strong acid

DOESN'T PERFORM WELL IN

- Ketones
- Low molecular weight organic acids (formic and acetic acids)
- Superheat steam
- Low molecular weight esters and ethers
- Phosphate ester based hydraulic fluids Skydrol®

VITON®-75 O-RING

TEST REPORT FOR COMPOUND V75

DUROMETER: 75

COLOR: BLACK

ASTM* D2000, M2HK810, A1-10, B38, EF31, E078, Z1, Z2

SECTION OF SPEC.	PROPERTIES	REQUIREMENTS	RESULTS	ASTM TEST METHOD
Z1	ORIGINAL PHYSICAL PROPERTIES			
	Hardness, Shore A	75 ± 5	75	D2240-05
	Tensile Strength	1450 PSI (min)	2273 PSI (15.6 MPa)	D412-06a
	Elongation	150% (min)	203%	D412-06a
	Modulus at 100%		932 PSI (6.4 MPa)	D412-06a
	Specific Gravity		1.85 g/cm ³	
A1-10	HEAT AGE: 70 hours at 250°C (482°F)			
	Hardness Change	± 10 points	+2 points	D573-04
	Tensile Strength Change	-25% (max)	-1%	
	Elongation Change	-25% (max)	-3%	
Weight Change		-1.7%		
B38	COMPRESSION SET: 22 hours at 200°C (392°F)	50% (plied) (max)	11%	D395-03, Method B
EF31	FUEL C RESISTANCE: 70 hours at 23°C (73.4°F)			
	Hardness Change	± 5 points	-2 points	D471-06
	Tensile Strength Change	-25% (max)	-7%	
	Elongation Change	-20% (max)	-10%	
Volume Change	0% to +10%	+3.4%		
E078	NO. 101 OIL: 70 hours at 200°C (392°F)			
	Hardness Change	-15 to +5 points	-9 points	D471-06
	Tensile Strength Change	-40% (max)	-30%	
	Elongation Change	-20% (max)	-6%	
Volume Change	0% to +15%	+13.3%		

*American Society for Testing and Materials



VITON®-90 O-RING

TEST REPORT FOR COMPOUND V90

DUROMETER: 75

COLOR: BLACK

ASTM* D2000, M2HK810, A1-10, B38, EF31, E078, Z1, Z2

SECTION OF SPEC.	PROPERTIES	REQUIREMENTS	RESULTS	ASTM TEST METHOD
	ORIGINAL PHYSICAL PROPERTIES			
	Hardness, Shore A	90 ± 5	90	D2240-05
	Tensile Strength	1450 PSI (min)	2256 PSI (15.56 MPa)	D412-06a
	Elongation	100% (min)	137%	D412-06a
	Modulus at 100%		1656 PSI (11.42 MPa)	D412-06a
	Specific Gravity		1.837 g/cm ³	
	HEAT AGE: 70 hours at 250°C (482°F)			
A1-10	Hardness Change	± 10 points	+3 points	D573-04
	Tensile Strength Change	-25% (max)	-11%	
	Elongation Change	-25% (max)	-12%	
	Weight Change		-1.7%	
B38	COMPRESSION SET: 22 hours at 200°C (392°F)	50% (plied) (max)	20.4%	D395-03, Method B
	FUEL C RESISTANCE: 70 hours at 23°C (73.4°F)			
EF31	Hardness Change	± 5 points	-1 points	D471-06
	Tensile Strength Change	-25% (max)	-14%	
	Elongation Change	-20% (max)	-10%	
	Volume Change	0% to +10%	+2.7%	
	NO. 101 OIL: 70 hours at 200°C (392°F)			
E078	Hardness Change	-15 to +5 points	-8 points	D471-06
	Tensile Strength Change	-40% (max)	-24%	
	Elongation Change	-20% (max)	-1%	
	Volume Change	0% to +15%	+10.9%	
	7700/SAE OIL: 70 hours at 200°C (392°F)			
EF31	Hardness Change	-15 to +5 points	-11 points	D471-06
	Tensile Strength Change	-40% (max)	-16%	
	Elongation Change	-20% (max)	-8%	
	Volume Change	+25%	+15.3%	

*American Society for Testing and Materials

NEOPRENE-70 O-RING

MATERIAL: Neoprene (Chloroprene Rubber)

MATERIAL DESCRIPTION

Chloroprene (CR), also known by its trade name “Neoprene”, was one of the first successful synthetic elastomers in 1931 made by Dupont. It is prepared by emulsion polymerization of chloroprene, or 2 chlorobutadiene. CR is a multi purposed elastomer which yields a balanced combination of properties. It performs well in contact with oils and many chemicals and has good resistance to sun, ozone and weather. It also displays outstanding toughness and good resistance to fire.

CURE SYSTEM: SULFUR-CURED

Standard FKM compounds are Bisphenol cured. FKM compounds with peroxide cured possess better acid solution resistance than the bisphenol cured and can replace litharge cured applied in acid solutions. In some lubricants, adding a few organic amide or amine, or choosing peroxide cured system Viton® will be better than bisphenol curing systems.

OTHER COMMON VARIATIONS

- CR has been used in thousands of diverse environments, including the automotive, wire and cable industries.
- CR is most often used in air condition systems, especially old refrigerated media like R12 or R22 and lubricants with mineral oils.

GENERAL INFORMATION

ASTM D1418 DESIGNATION	CR	STANDARD COLOR	Black
ISO/DIN 1629 DESIGNATION	CR	HARDNESS RANGE	30 to 90 Shore A
ASTM D2000/ SAE J 200 CODES	BC, BE	RELATIVE COST	Low

SERVICE TEMPERATURES

STANDARD LOW TEMPERATURE	-40°F -40°C	SPECIAL COMPOUND LOW TEMPERATURE	-67°F -55°C
STANDARD HIGH TEMPERATURE	212°F 100°C	SPECIAL COMPOUND HIGH TEMPERATURE	257°F 125°C



PERFORMS WELL IN

- Refrigerants
- Ammonia
- Water
- Silicone grease and oils
- High aniline point mineral oil

DOESN'T PERFORM WELL IN

- Aromatic hydrocarbons
- Ketones
- Esters
- Ethers
- Strong oxidizing acids
- Chlorinated hydrocarbons

TEST REPORT FOR COMPOUND C70

DUROMETER: 70

COLOR: BLACK

ASTM* D2000, M2BC710, A14, C12, F17, Z1, Z2

SECTION OF SPEC.	PROPERTIES	REQUIREMENTS	RESULTS	ASTM TEST METHOD
	ORIGINAL PHYSICAL PROPERTIES			
	Hardness, Shore A	70 ± 5	70	D2240-04
	Tensile Strength	1450 PSI (min)	2269 PSI (15.65 MPa)	D412-98a
	Elongation	250% (min)	282%	D412-98a
	Modulus at 100%		652 PSI (4.50 MPa)	D412-98a
	Specific Gravity		1.388 g/cm ³	
A14	HEAT AGE: 70 hours at 100°C (212°F)			
	Hardness Change	± 15 points (max)	+9 points	D573-04
	Tensile Strength Change	-15% (max)	-1%	
	Elongation Change	-40% (max)	-9%	
	Weight Change		-2.8%	
Z1	COMPRESSION SET: 70 hours at 100°C (212°F)	35% (button) (max)	33.2%	D395-03, Method B
C12	OZONE RESISTANCE: 50 ppm, 70 hours at 40°C (104°F)	No crack	Pass	D1171-99
F17	LOW TEMPERATURE BRITTLENESS POINT: 3 minutes at 40°C (40°F)			
	Sample type: T 50			D2137-94, Method A
	Coolant : Methanol			
	Brittleness temperature to nearest 1°C (1°F)	No crack	Pass	

*American Society for Testing and Materials

EPDM-70 O-RING

MATERIAL: Ethylene Propylene (EPR, EPDM)

MATERIAL DESCRIPTION

Ethylene Propylene Rubber (EPDM) is a Copolymer of ethylene and propylene. Furthermore, it is a terpolymer of ethylene and propylene with a small amount of a third monomer (usually a diolefin) to permit vulcanization with sulfur. Generally, EPDM possesses an excellent resistance to ozone, sunlight and weathering, and has very good flexibility at low temperature, good chemical resistance (many dilute acids and alkalis as well as polar solvents) and good electrical insulation property.

CURE SYSTEM: PEROXIDE-CURED

Standard EPDMs are usually sulfur cured. Sulfur cured compounds offer better flexible properties but are more prone to hardening and have an inferior compression set with high temperature. Peroxide cured EPDMs have better heat resistance and a lower compression set. It complies with long time usage, especially for hose systems in the construction industry, but is more expensive and more difficult for production than the sulfur cured EPDMs.

OTHER COMMON VARIATIONS

- EPDMs often are internally lubricated to improve ease of installation or reduce friction for dynamic applications.
- EPDMs can be formulated with only “white list” ingredients, as specified in 21.CFR 177.2600, for use in applications where the elastomer will be in contact with food or beverages.
- EPDMs can be submitted for approval by the National Sanitation Foundation (NSF) for use in drinking water applications.
- EPDMs are usually used in automotive air conditioning systems where there is use of R134a refrigerant gas and POE or PAG lubricant and new refrigerant for environment protection R744. R744 air conditioning systems require excellent resistance to explosive decompression in hydrogen dioxide at high pressure and high temperature.
- EPDMs are usually used in phosphate ester type hydraulic fluids.

GENERAL INFORMATION

ASTM D1418 DESIGNATION	EPM, EPDM	STANDARD COLOR	Black
ISO/DIN 1629 DESIGNATION	EPM, EPDM	HARDNESS RANGE	30 to 90 Shore A
ASTM D2000/ SAE J 200 CODES	AA, BA, CA, DA	RELATIVE COST	Low

SERVICE TEMPERATURES

STANDARD LOW TEMPERATURE	-67°F -55°C	SPECIAL COMPOUND LOW TEMPERATURE	-67°F -55°C
STANDARD HIGH TEMPERATURE	257°F 125°C	SPECIAL COMPOUND HIGH TEMPERATURE	302°F 150°C



PERFORMS WELL IN

- Alcohols
- Automotive brake fluid
- Ketones
- Dilute acids and alkalis
- Silicone oils and greases
- Steam up to 204.4°C (400°F)
- Water
- Phosphate ester based hydraulic fluids Skydrol®
- Ozone, aging and weathering

DOESN'T PERFORM WELL IN

- Aliphatic and aromatic hydrocarbons
- Di ester based lubricants
- Halogenated solvents
- Petroleum based oils and greases

TEST REPORT FOR COMPOUND E70

DUROMETER: 70

COLOR: BLACK

ASTM* D2000, M4CA714, A25, B44, EA14, F17, Z1, Z2

SECTION OF SPEC.	PROPERTIES	REQUIREMENTS	RESULTS	ASTM TEST METHOD
	ORIGINAL PHYSICAL PROPERTIES			
	Hardness, Shore A	70 ± 5	75	D2240-05
	Tensile Strength	2031 PSI (min)	2429 PSI (16.75 MPa)	D412-06a
	Elongation	200% (min)	259%	D412-06a
	Modulus at 100%		753 PSI (5.19 MPa)	D412-06a
	Specific Gravity		1.144 g/cm ³	
A25	HEAT AGE: 70 hours at 125°C (257°F)			
	Hardness Change	± 10 points	+4 points	D573-04
	Tensile Strength Change	-20% (max)	-7%	
	Elongation Change	-40% (max)	-6%	
	Weight Change		-2.9%	
B44	COMPRESSION SET: 70 hours at 100°C (212°F)	50% (plied) (max)	8.5%	D395-03, Method B
EA14	WATER RESISTANCE: 70 hours at 100°C (212°F)			
	Hardness Change		-3 points	D471-06
	Tensile Strength Change		-13%	
	Elongation Change		+2%	
	Volume Change	± 5%	+4.1%	
F17	LOW TEMPERATURE BRITTLENESS POINT: 3 minutes at 40°C (40°F)			
	Sample type: T 50			D2137-05, Method A
	Coolant : Methanol			
	Brittleness temperature to nearest 1°C (1°F)	No crack	Pass	

*American Society for Testing and Materials

SILICONE-70 O-RING

MATERIAL: Silicone Rubber (MQ, VMO, PVMQ)

MATERIAL DESCRIPTION

Physically, silicones are based on silicon, an element derived from quartz. To create this class of synthetic elastomers, pendant organic groups such as methyl, phenyl and vinyl are attached to silicon atoms. Different additions of side chains can achieve significant variations in properties. Silicones have excellent heat, ozone and corona resistance and have good dielectric stability and resistance to many oils, chemicals and solvents. Silicones possess the best flexible property at low temperature but have low tensile strength and poor wear and tear resistance.

CURE SYSTEM: PEROXIDE-CURED

Standard silicone compounds are usually peroxide cured. Platinum cured compounds offer better flexible properties and very low volatile matter. Platinum cured silicones usually are applied in medical systems or other required low volatile matter. However, they need to be produced in a clean room and with a higher cost of platinum catalyzer, making them more expensive than peroxide cured ones.

OTHER COMMON VARIATIONS

- Silicones can be formulated with only “white list” ingredients, as specified in 21.CFR 177.2600, for use in applications where the elastomer will be in contact with food or beverages.
- Silicones can be submitted for approval by the National Sanitation Foundation (NSF) for use in drinking water applications.
- Silicones are most often used in automotive systems in boots, oil filter valves, gasket in light, etc.
- Silicone parts can be used in medical systems which especially require compliance to USP CLASS VI

GENERAL INFORMATION

ASTM D1418 DESIGNATION	Q, MQ, VMO, PVMQ	STANDARD COLOR	Rust
ISO/DIN 1629 DESIGNATION	Q, MQ, VMO, PVMQ	HARDNESS RANGE	25 to 90 Shore A
ASTM D2000/ SAE J 200 CODES	FC, FE, GE	RELATIVE COST	Medium to High

SERVICE TEMPERATURES

STANDARD LOW TEMPERATURE	-76°F -60°C	SPECIAL COMPOUND LOW TEMPERATURE	-150°F -100°C
STANDARD HIGH TEMPERATURE	437°F 225°C	SPECIAL COMPOUND HIGH TEMPERATURE	572°F 300°C



PERFORMS WELL IN

- Petroleum products
- Fuel or blend with methanol or ethanol
- Diesel or blend with biodiesel
- Mineral oil and grease
- Silicone oil and grease
- High vacuum
- Ozone, weather and very high temperature air
- Strong acid

DOESN'T PERFORM WELL IN

- Ketones
- Low molecular weight organic acids (formic and acetic acids)
- Superheat steam
- Low molecular weight esters and ethers
- Phosphate ester based hydraulic fluids Skydrol®

SILICONE-70 O-RING continued

TEST REPORT FOR COMPOUND S70

DUROMETER: 70

COLOR: RUST

ASTM* D2000, M5GE706, A19, B37, EO16, EO36, EA14, F19, Z1

SECTION OF SPEC.	PROPERTIES	REQUIREMENTS	RESULTS	ASTM TEST METHOD
	ORIGINAL PHYSICAL PROPERTIES			
	Hardness, Shore A	70 ± 5	69.5	D2240-05
	Tensile Strength	870 PSI (min)	910 PSI (6.3 MPa)	D412-06a
	Elongation	150% (min)	247%	D412-06a
	Modulus at 100%		567 PSI (3.9 MPa)	D412-06a
	Specific Gravity		1.33 g/cm ³	
A19	HEAT AGE: 70 hours at 225°C (437°F)			
	Hardness Change	± 10 points	+6 points	D573-04
	Tensile Strength Change	-25% (max)	+4%	
	Elongation Change	-30% (max)	-28%	
	Weight Change		-4%	
B37	COMPRESSION SET: 22 hours at 175°C (347°F)	25% (plied) (max)	17.6%	D395-03, Method B
EO16	IRM 901 OIL: 70 hours at 150°C (302°F)			
	Hardness Change	0 to -15	-4 points	D471-06
	Tensile Strength Change	-20 (max)	+11%	
	Elongation Change	-20 (max)	0%	
	Volume Change	0% to +10%	+4%	
EA036	IRM 903 OIL: 70 hours at 150°C (302°F)			
	Hardness Change	-30 points (max)	-19 points	D471-06
	Tensile Strength Change		-14%	
	Elongation Change		+3%	
	Volume Change	+60% (max)	+33.7%	
EA14	WATER RESISTANCE: 70 hours at 100°C (212°F)			
	Hardness Change	± 5%	0 points	D471-06
	Tensile Strength Change		-3%	
	Elongation Change		-20%	
	Volume Change	± 5%	+1.9%	
F17	LOW TEMPERATURE BRITTLINESS POINT: 3 minutes at 55°C (40°F)			
	Sample type: T 50			D2137-05, Method A
	Coolant : Methanol			
	Brittleness temperature to nearest 1°C (1°F)	No crack	Pass	

*American Society for Testing and Materials



TEFLON® O-RING

MATERIAL: Polytetrafluoroethylene (PTFE)

MATERIAL DESCRIPTION

Polytetrafluoroethylene (PTFE) is a high molecular weight polymer, one of the most versatile plastic materials known and useful for a large range of products for applications excluded to other materials.

PTFE is generally considered a thermoplastic polymer; at 327°C (620.6°F) it retains a very high viscosity, thus requiring particular transformation techniques for manufacturing of finished and semi finished goods. PTFE can be used in a temperature range from 200°C (328°F) to +260°C (500°F).

OUTSTANDING CHARACTERISTICS

- High heat resistance
- High resistance to chemical agents and solvents • High anti adhesiveness
- High dielectric properties
- Low friction coefficient
- Non toxicity

THERMAL PROPERTIES

PTFE is one of the most thermally stable plastic materials. There is no appreciable decomposition at 260°C (500°F), so that PTFE, at this temperature, still possesses the greater part of its properties. Appreciable decomposition begins at over 400°C (932°F). The coefficient of the thermal conductivity of PTFE does not vary with the temperature. It is relatively high, so that PTFE can be considered to be a good insulating material. The mixing of suitable fillers improves the thermal conductivity.

BEHAVIOR IN PRESENCE OF FOREIGN AGENTS

PTFE is practically inert against known elements and compounds. It is attacked only by the alkaline metals in the elementary state, by Chlorine trifluoride and by elementary Fluorine at high temperatures and pressures. PTFE is insoluble in almost all solvents at temperatures up to about 300°C (572°F). Fluorinated hydrocarbons cause a certain swelling which is however reversible; some highly fluorinated oils, at temperatures over 300°C (572°F), exercise a certain dissolving effect upon PTFE. High energy radiation tends to cause the breaking of the PTFE molecule, so that the resistance of the product to radiation is rather poor. The gas permeability of PTFE is similar to other plastic materials. The permeability does not depend only on the thickness and pressure, but also on the working techniques.

PHYSICAL MECHANICAL PROPERTIES

The tensile and compressive properties are to a large degree influenced by the working processes and the polymer used. PTFE, however, can be used continuously at temperatures up to 260°C (500°F), while possessing still a certain compressive plasticity at temperatures near to the absolute Zero.

The hardness Shore D, measured according to the method ASTM D 2240, has values comprised between D50 and D60. According DIN 53456 (load 13.5 Kg for 30 sec.) results in an hardness range between 27 and 32 N/mm².

* RAGCO supports the autonomy of its locations to select the best products to service their markets. Subtle variations of these specification may exist. Contact your RAGCO affiliate for confirmation.

TEST REPORT FOR COMPOUND TEF

DUROMETER: 50 - 60 SHORE D

COLOR: WHITE

PROPERTIES	RESULTS	ASTM* TEST METHOD
Density	2.14 - 2.18 g/cm ³	D792
Tensile Strength	≥ 20 N/mm ²	D4894
Elongation at Break	≥ 200%	D4894
Compressive Strength at 1% Deformation	4 -5 N/mm ²	D695
Coefficient of Friction (dynamic)	0.06	D1894
Service Temperature (min max)	-200°C (-328°F) min +260°C (500°F) max	
Dielectric Strength in Air	1.33 g/cm ³	D149

*American Society for Testing and Materials



POLYURETHANE O-RING OVERVIEW

MATERIAL: Polyurethane Rubber (PU, AU, EU)

MATERIAL DESCRIPTION

The millable Polyurethane (PU) rubbers are distinguished into two types; the first is polyester urethane (AU) and the other is polyether urethane (EU). AU type urethanes have outstanding oil, fuel and solvent resistance but can be attacked by hydrolysis. EU type urethanes are not attacked by hydrolysis and still offer a fuel and oil resistance comparable to low ACN (18 to 22% ACN) Nitriles or HNBRs. Any type polyurethane has excellent wear resistance, high tensile strength and high elasticity in comparison with any other elastomers. We can also offer any type thermoplastic urethane (TPU).

CURE SYSTEM: PEROXIDE-CURED Standard PU compounds are peroxide cured.

OTHER COMMON VARIATIONS

- Polyurethane usually is applied in the mechanical industry, especially in places where material must have higher wear resistance and strength.
- In some applying environments, moisture condensing will happen on the surface of the rubber seal; this will cause hydrolysis of AU so choosing EU is better in these cases. However, EU does not resist oil very well, thus higher aniline point oil must be used for lubricant application.
- TPU will be better than millable polyurethane when applied in hydraulic systems.

GENERAL INFORMATION

ASTM D1418 DESIGNATION	AU, EU	STANDARD COLOR	Transparent
ISO/DIN 1629 DESIGNATION	AU, EU	HARDNESS RANGE	60 to 93 Shore A
ASTM D2000/ SAE J 200 CODES	BG	RELATIVE COST	Medium to High

SERVICE TEMPERATURES

STANDARD LOW TEMPERATURE	-40°F -40°C	SPECIAL COMPOUND LOW TEMPERATURE	-67°F -55°C
STANDARD HIGH TEMPERATURE	176°F 80°C	SPECIAL COMPOUND HIGH TEMPERATURE	212°F 100°C

PERFORMS WELL IN

- Aliphatic hydrocarbon
- Mineral oil and grease
- Silicone oil and grease
- Ozone
- Water up to 50°C (122°F) EU type

DOESN'T PERFORM WELL IN

- Ketones
- Alcohols
- Esters
- Ethers
- Hot water and steam
- Alkalis, amines
- Acids
- Glycols

* RAGCO supports the autonomy of its locations to select the best products to service their markets. Subtle variations of these specification may exist. Contact your RAGCO affiliate for confirmation.

POLYURETHANE-70 O-RING

TEST REPORT FOR COMPOUND U70

DUROMETER: 70

COLOR: TRANSPARENT

ASTM* D2000, M3BG714, B14, EA14, EO14, Z1, Z2

SECTION OF SPEC.	PROPERTIES	REQUIREMENTS	RESULTS	ASTM TEST METHOD
	ORIGINAL PHYSICAL PROPERTIES			
	Hardness, Shore A	70 ± 5	69	D2240-05
	Tensile Strength	2031 PSI (min)	2922 PSI (20.15 MPa)	D412-06a
	Elongation	250% (min)	458%	D412-06a
	Modulus at 100%		310 PSI (2.14 MPa)	D412-06a
	Specific Gravity		1.147 g/cm ³	
B14	COMPRESSION SET: 22 hours at 100°C (212°F)	50% (button) (max)	45.6%	D395-03, Method B
EA14	WATER RESISTANCE: 70 hours at 100°C (212°F)			
	Hardness Change	± 10 points	-5 points	D471-06
	Tensile Strength Change		-27%	
	Elongation Change		-16%	
	Volume Change	± 15%	+5%	
EO14	NO. 1 OIL RESISTANCE: 70 hours at 100°C (212°F)			
	Hardness Change	-7 to +5 points	-4 points	D471-06
	Tensile Strength Change	-20% (max)	-6%	
	Elongation Change	-40% (max)	-8%	
	Volume Change	-5% to +10%	+6.4%	
Z2	NO. 3 OIL RESISTANCE: 70 hours at 100°C (212°F)			
	Hardness Change		-30 points	D471-06
	Tensile Strength Change		-46%	
	Elongation Change		-32%	
	Volume Change		+56.1%	

*American Society for Testing and Materials



POLYURETHANE-90 O-RING

TEST REPORT FOR COMPOUND U90

DUROMETER: 90

COLOR: TRANSPARENT

ASTM* D2000, M3BG910, A14, B14, EA14, EO14, Z1, Z2, Z3

SECTION OF SPEC.	PROPERTIES	REQUIREMENTS	RESULTS	ASTM TEST METHOD
	ORIGINAL PHYSICAL PROPERTIES			
	Hardness, Shore A	90 ± 5	91	D2240-04
	Tensile Strength	1450 PSI (min)	2847 PSI (19.63 MPa)	D412-98a
	Elongation	100% (min)	180%	D412-98a
	Modulus at 100%		1659 PSI (11.44 MPa)	D412-98a
	Specific Gravity		1.231 g/cm ³	
	HEAT AGE: 70 hours at 100°C (212°F)			
A14	Hardness Change	± 15 points	0 points	D573-04
	Tensile Strength Change	-20% (max)	-15%	
	Elongation Change	-40% (max)	-18%	
	Weight Change		+0.1%	
B14	COMPRESSION SET: 22 hours at 100°C (212°F)	50% (button) (max)	29.5%	D395-03, Method B
	WATER RESISTANCE: 70 hours at 100°C (212°F)			
EA14	Hardness Change	± 10 points	-1 points	D471-98
	Tensile Strength Change		-1%	
	Elongation Change		+8%	
	Volume Change	± 15%	+3.9%	
	NO. 1 OIL RESISTANCE: 70 hours at 100°C (212°F)			
EO14	Hardness Change	-7 to +5 points	-2 points	D471-98
	Tensile Strength Change	-20% (max)	-17%	
	Elongation Change	-40% (max)	-16%	
	Volume Change	-5% to +10%	+4.8%	
Z3	TENSILE SET: Hold 100% Elongation for 2 minutes, Release tension and rest 2 minutes		10.2%	

*American Society for Testing and Materials

STANDARD O-RING SIZES

AS568 SIZE CHART (continued)

AS568	Nominal Reference			Actual Dimensions					
				Inches			Metric		
Dash #	CS (IN)	ID (IN)	OD (IN)	CS	ID	ID Tol	CS	ID	ID Tol
001	1/32	1/32	3/32	0.040	0.029	± 0.004	1.02	0.74	± 0.10
002	3/64	3/64	9/64	0.050	0.042	± 0.004	1.27	1.07	± 0.10
003	1/16	1/16	3/16	0.060	0.056	± 0.004	1.52	1.42	± 0.10
004	1/16	5/64	13/64	0.070	0.070	± 0.005	1.78	1.78	± 0.13
005	1/16	3/32	7/32	0.070	0.101	± 0.005	1.78	2.57	± 0.13
006	1/16	1/8	1/4	0.070	0.114	± 0.005	1.78	2.90	± 0.13
007	1/16	5/32	9/32	0.070	0.145	± 0.005	1.78	3.68	± 0.13
008	1/16	3/16	5/16	0.070	0.176	± 0.005	1.78	4.47	± 0.13
009	1/16	7/32	11/32	0.070	0.208	± 0.005	1.78	5.28	± 0.13
010	1/16	1/4	3/8	0.070	0.239	± 0.005	1.78	6.07	± 0.13
011	1/16	5/16	7/16	0.070	0.301	± 0.005	1.78	7.65	± 0.13
012	1/16	3/8	1/2	0.070	0.364	± 0.005	1.78	9.25	± 0.13
013	1/16	7/16	9/16	0.070	0.426	± 0.005	1.78	10.82	± 0.13
014	1/16	1/2	5/8	0.070	0.489	± 0.005	1.78	12.42	± 0.13
015	1/16	9/16	11/16	0.070	0.551	± 0.007	1.78	14.00	± 0.18
016	1/16	5/8	3/4	0.070	0.614	± 0.009	1.78	15.60	± 0.23
017	1/16	11/16	13/16	0.070	0.676	± 0.009	1.78	17.17	± 0.23
018	1/16	3/4	7/8	0.070	0.739	± 0.009	1.78	18.77	± 0.23
019	1/16	13/16	15/16	0.070	0.801	± 0.009	1.78	20.35	± 0.23
020	1/16	7/8	1	0.070	0.864	± 0.009	1.78	21.95	± 0.23
021	1/16	15/16	1-1/16	0.070	0.926	± 0.009	1.78	23.52	± 0.23
022	1/16	1	1-1/8	0.070	0.989	± 0.010	1.78	25.12	± 0.25
023	1/16	1-1/16	1-3/16	0.070	1.051	± 0.010	1.78	26.70	± 0.25
024	1/16	1-1/8	1-1/4	0.070	1.114	± 0.010	1.78	28.30	± 0.25
025	1/16	1-3/16	1-5/16	0.070	1.176	± 0.011	1.78	29.87	± 0.28
026	1/16	1-1/4	1-3/8	0.070	1.239	± 0.011	1.78	31.47	± 0.28
027	1/16	1-5/16	1-7/16	0.070	1.301	± 0.011	1.78	33.05	± 0.28
028	1/16	1-3/8	1-1/2	0.070	1.364	± 0.013	1.78	34.65	± 0.33
029	1/16	1-1/2	1-5/8	0.070	1.489	± 0.013	1.78	37.82	± 0.33
030	1/16	1-5/8	1-3/4	0.070	1.614	± 0.013	1.78	41.00	± 0.33
031	1/16	1-3/4	1-7/8	0.070	1.739	± 0.015	1.78	44.17	± 0.38
032	1/16	1-7/8	2	0.070	1.864	± 0.015	1.78	47.35	± 0.38
033	1/16	2	2-1/8	0.070	1.989	± 0.018	1.78	50.52	± 0.46
034	1/16	2-1/8	2-1/4	0.070	2.114	± 0.018	1.78	53.70	± 0.46
035	1/16	2-1/4	2-3/8	0.070	2.239	± 0.018	1.78	56.87	± 0.46
036	1/16	2-3/8	2-1/2	0.070	2.364	± 0.018	1.78	60.05	± 0.46
037	1/16	2-1/2	2-5/8	0.070	2.489	± 0.018	1.78	63.22	± 0.46
038	1/16	2-5/8	2-3/4	0.070	2.614	± 0.020	1.78	66.40	± 0.51
039	1/16	2-3/4	2-7/8	0.070	2.739	± 0.020	1.78	69.57	± 0.51
040	1/16	2-7/8	3	0.070	2.864	± 0.020	1.78	72.75	± 0.51
041	1/16	3	3-1/8	0.070	2.989	± 0.024	1.78	75.92	± 0.61



AS568 SIZE CHART (continued)

AS568	Nominal Reference			Actual Dimensions					
				Inches			Metric		
Dash #	CS (IN)	ID (IN)	OD (IN)	CS	ID	ID Tol	CS	ID	ID Tol
042	1/16	3-1/4	3-3/8	0.070	3.239	± 0.024	1.78	82.27	± 0.61
043	1/16	3-1/2	3-5/8	0.070	3.489	± 0.024	1.78	88.62	± 0.61
044	1/16	3-3/4	3-7/8	0.070	3.739	± 0.027	1.78	94.97	± 0.69
045	1/16	4	4-1/8	0.070	3.989	± 0.027	1.78	101.32	± 0.69
046	1/16	4-1/4	4-3/8	0.070	4.239	± 0.030	1.78	107.67	± 0.76
047	1/16	4-1/2	4-5/8	0.070	4.489	± 0.030	1.78	114.02	± 0.76
048	1/16	4-3/4	4-7/8	0.070	4.739	± 0.030	1.78	120.37	± 0.76
049	1/16	5	5-1/8	0.070	4.989	± 0.037	1.78	126.72	± 0.94
050	1/16	5-1/4	5-3/8	0.070	5.239	± 0.037	1.78	133.07	± 0.94
102	3/32	1/16	1/4	0.103	0.049	± 0.005	2.62	1.24	± 0.13
103	3/32	3/32	9/32	0.103	0.081	± 0.005	2.62	2.06	± 0.13
104	3/32	1/8	5/16	0.103	0.112	± 0.005	2.62	2.84	± 0.13
105	3/32	5/32	11/32	0.103	0.143	± 0.005	2.62	3.63	± 0.13
106	3/32	3/16	3/8	0.103	0.174	± 0.005	2.62	4.42	± 0.13
107	3/32	7/32	13/32	0.103	0.206	± 0.005	2.62	5.23	± 0.13
108	3/32	1/4	7/16	0.103	0.237	± 0.005	2.62	6.02	± 0.13
109	3/32	5/16	1/2	0.103	0.299	± 0.005	2.62	7.59	± 0.13
110	3/32	3/8	9/16	0.103	0.362	± 0.005	2.62	9.19	± 0.13
111	3/32	7/16	5/8	0.103	0.424	± 0.005	2.62	10.77	± 0.13
112	3/32	1/2	11/16	0.103	0.487	± 0.005	2.62	12.37	± 0.13
113	3/32	9/16	3/4	0.103	0.549	± 0.007	2.62	13.94	± 0.18
114	3/32	5/8	13/16	0.103	0.612	± 0.009	2.62	15.54	± 0.23
115	3/32	11/16	7/8	0.103	0.674	± 0.009	2.62	17.12	± 0.23
116	3/32	3/4	15/16	0.103	0.737	± 0.009	2.62	18.72	± 0.23
117	3/32	13/16	1	0.103	0.799	± 0.010	2.62	20.29	± 0.25
118	3/32	7/8	1-1/16	0.103	0.862	± 0.010	2.62	21.89	± 0.25
119	3/32	15/16	1-1/8	0.103	0.924	± 0.010	2.62	23.47	± 0.25
120	3/32	1	1-3/16	0.103	0.987	± 0.010	2.62	25.07	± 0.25
121	3/32	1-1/16	1-1/4	0.103	1.049	± 0.010	2.62	26.64	± 0.25
122	3/32	1-1/8	1-5/16	0.103	1.112	± 0.010	2.62	28.24	± 0.25
123	3/32	1-3/16	1-3/8	0.103	1.174	± 0.012	2.62	29.82	± 0.30
124	3/32	1-1/4	1-7/16	0.103	1.237	± 0.012	2.62	31.42	± 0.30
125	3/32	1-5/16	1-1/2	0.103	1.299	± 0.012	2.62	32.99	± 0.30
126	3/32	1-3/8	1-9/16	0.103	1.362	± 0.012	2.62	34.59	± 0.30
127	3/32	1-7/16	1-5/8	0.103	1.424	± 0.012	2.62	36.17	± 0.30
128	3/32	1-1/2	1-11/16	0.103	1.487	± 0.012	2.62	37.77	± 0.30
129	3/32	1-9/16	1-3/4	0.103	1.549	± 0.015	2.62	39.34	± 0.38
130	3/32	1-5/8	1-13/16	0.103	1.612	± 0.015	2.62	40.94	± 0.38
131	3/32	1-11/16	1-7/8	0.103	1.674	± 0.015	2.62	42.52	± 0.38
132	3/32	1-3/4	1-15/16	0.103	1.737	± 0.015	2.62	44.12	± 0.38
133	3/32	1-13/16	2	0.103	1.799	± 0.015	2.62	45.69	± 0.38

* RAGCO supports the autonomy of its locations to select the best products to service their markets. Subtle variations of these specification may exist. Contact your RAGCO affiliate for confirmation.

STANDARD O-RING SIZES continued

AS568 SIZE CHART (continued)

AS568	Nominal Reference			Actual Dimensions					
				Inches			Metric		
Dash #	CS (IN)	ID (IN)	OD (IN)	CS	ID	ID Tol	CS	ID	ID Tol
134	3/32	1-7/8	2-1/16	0.103	1.862	± 0.015	2.62	47.29	± 0.38
135	3/32	1-15/16	2-1/8	0.103	1.925	± 0.017	2.62	48.90	± 0.43
136	3/32	2	2-3/16	0.103	1.987	± 0.017	2.62	50.47	± 0.43
137	3/32	2-1/16	2-1/4	0.103	2.050	± 0.017	2.62	52.07	± 0.43
138	3/32	2-1/8	2-5/16	0.103	2.112	± 0.017	2.62	53.64	± 0.43
139	3/32	2-3/16	2-3/8	0.103	2.175	± 0.017	2.62	55.25	± 0.43
140	3/32	2-1/4	2-7/16	0.103	2.237	± 0.017	2.62	56.82	± 0.43
141	3/32	2-5/16	2-1/2	0.103	2.300	± 0.020	2.62	58.42	± 0.51
142	3/32	2-3/8	2-9/16	0.103	2.362	± 0.020	2.62	59.99	± 0.51
143	3/32	2-7/16	2-5/8	0.103	2.425	± 0.020	2.62	61.60	± 0.51
144	3/32	2-1/2	2-11/16	0.103	2.487	± 0.020	2.62	63.17	± 0.51
145	3/32	2-9/16	2-3/4	0.103	2.550	± 0.020	2.62	64.77	± 0.51
146	3/32	2-5/8	2-13/16	0.103	2.612	± 0.020	2.62	66.34	± 0.51
147	3/32	2-11/16	2-7/8	0.103	2.675	± 0.022	2.62	67.95	± 0.56
148	3/32	2-3/4	2-15/16	0.103	2.737	± 0.022	2.62	69.52	± 0.56
149	3/32	2-13/16	3	0.103	2.800	± 0.022	2.62	71.12	± 0.56
150	3/32	2-7/8	3-1/16	0.103	2.862	± 0.022	2.62	72.69	± 0.56
151	3/32	3	3-3/16	0.103	2.987	± 0.024	2.62	75.87	± 0.61
152	3/32	3-1/4	3-7/16	0.103	3.237	± 0.024	2.62	82.22	± 0.61
153	3/32	3-1/2	3-11/16	0.103	3.487	± 0.024	2.62	88.57	± 0.61
154	3/32	3-3/4	3-15/16	0.103	3.737	± 0.028	2.62	94.92	± 0.71
155	3/32	4	4-3/16	0.103	3.987	± 0.028	2.62	101.27	± 0.71
156	3/32	4-1/4	4-7/16	0.103	4.237	± 0.030	2.62	107.62	± 0.76
157	3/32	4-1/2	4-11/16	0.103	4.487	± 0.030	2.62	113.97	± 0.76
158	3/32	4-3/4	4-15/16	0.103	4.737	± 0.030	2.62	120.32	± 0.76
159	3/32	5	5-3/16	0.103	4.987	± 0.035	2.62	126.67	± 0.89
160	3/32	5-1/4	5-7/16	0.103	5.237	± 0.035	2.62	133.02	± 0.89
161	3/32	5-1/2	5-11/16	0.103	5.487	± 0.035	2.62	139.37	± 0.89
162	3/32	5-3/4	5-15/16	0.103	5.737	± 0.035	2.62	145.72	± 0.89
163	3/32	6	6-3/16	0.103	5.987	± 0.035	2.62	152.07	± 0.89
164	3/32	6-1/4	6-7/16	0.103	6.237	± 0.040	2.62	158.42	± 1.02
165	3/32	6-1/2	6-11/16	0.103	6.487	± 0.040	2.62	164.77	± 1.02
166	3/32	6-3/4	6-15/16	0.103	6.737	± 0.040	2.62	171.12	± 1.02
167	3/32	7	7-3/16	0.103	6.987	± 0.040	2.62	177.47	± 1.02
168	3/32	7-1/4	7-7/16	0.103	7.237	± 0.045	2.62	183.82	± 1.14
169	3/32	7-1/2	7-11/16	0.103	7.487	± 0.045	2.62	190.17	± 1.14
170	3/32	7-3/4	7-15/16	0.103	7.737	± 0.045	2.62	196.52	± 1.14
171	3/32	8	8-3/16	0.103	7.987	± 0.045	2.62	202.87	± 1.14
172	3/32	8-1/4	8-7/16	0.103	8.237	± 0.050	2.62	209.22	± 1.27
173	3/32	8-1/2	8-11/16	0.103	8.487	± 0.050	2.62	215.57	± 1.27
174	3/32	8-3/4	8-15/16	0.103	8.737	± 0.050	2.62	221.92	± 1.27



AS568 SIZE CHART (continued)

AS568	Nominal Reference			Actual Dimensions					
				Inches			Metric		
Dash #	CS (IN)	ID (IN)	OD (IN)	CS	ID	ID Tol	CS	ID	ID Tol
175	3/32	9	9-3/16	0.103	8.987	± 0.050	2.62	228.27	± 10.27
176	3/32	9-1/4	9-7/16	0.103	9.237	± 0.055	2.62	234.62	± 10.40
177	3/32	9-1/2	9-11/16	0.103	9.487	± 0.055	2.62	240.97	± 10.40
178	3/32	9-3/4	9-15/16	0.103	9.737	± 0.055	2.62	247.32	± 10.40
201	1/8	3/16	7/16	0.139	0.171	± 0.005	3.53	4.34	± 0.13
202	1/8	1/4	1/2	0.139	0.234	± 0.005	3.53	5.94	± 0.13
203	1/8	5/16	9/16	0.139	0.296	± 0.005	3.53	7.52	± 0.13
204	1/8	3/8	5/8	0.139	0.359	± 0.005	3.53	9.12	± 0.13
205	1/8	7/16	11/16	0.139	0.421	± 0.005	3.53	10.69	± 0.13
206	1/8	1/2	3/4	0.139	0.484	± 0.005	3.53	12.29	± 0.13
207	1/8	9/16	13/16	0.139	0.546	± 0.007	3.53	13.87	± 0.18
208	1/8	5/8	7/8	0.139	0.609	± 0.009	3.53	15.47	± 0.23
209	1/8	11/16	15/16	0.139	0.671	± 0.009	3.53	17.04	± 0.23
210	1/8	3/4	1	0.139	0.734	± 0.010	3.53	18.64	± 0.25
211	1/8	13/16	1-1/16	0.139	0.796	± 0.010	3.53	20.22	± 0.25
212	1/8	7/8	1-1/8	0.139	0.859	± 0.010	3.53	21.82	± 0.25
213	1/8	15/16	1-3/16	0.139	0.921	± 0.010	3.53	23.39	± 0.25
214	1/8	1	1-1/4	0.139	0.984	± 0.010	3.53	24.99	± 0.25
215	1/8	1-1/16	1-5/16	0.139	1.046	± 0.010	3.53	26.57	± 0.25
216	1/8	1-1/8	1-3/8	0.139	1.109	± 0.012	3.53	28.17	± 0.30
217	1/8	1-3/16	1-7/16	0.139	1.171	± 0.012	3.53	29.74	± 0.30
218	1/8	1-1/4	1-1/2	0.139	1.234	± 0.012	3.53	31.34	± 0.30
219	1/8	1-5/16	1-9/16	0.139	1.296	± 0.012	3.53	32.92	± 0.30
220	1/8	1-3/8	1-5/8	0.139	1.359	± 0.012	3.53	34.52	± 0.30
221	1/8	1-7/16	1-11/16	0.139	1.421	± 0.012	3.53	36.09	± 0.30
222	1/8	1-1/2	1-3/4	0.139	1.484	± 0.015	3.53	37.69	± 0.38
223	1/8	1-5/8	1-7/8	0.139	1.609	± 0.015	3.53	40.87	± 0.38
224	1/8	1-3/4	2	0.139	1.734	± 0.015	3.53	44.04	± 0.38
225	1/8	1-7/8	2-1/8	0.139	1.859	± 0.018	3.53	47.22	± 0.46
226	1/8	2	2-1/4	0.139	1.984	± 0.018	3.53	50.39	± 0.46
227	1/8	2-1/8	2-3/8	0.139	2.109	± 0.018	3.53	53.57	± 0.46
228	1/8	2-1/4	2-1/2	0.139	2.234	± 0.020	3.53	56.74	± 0.51
229	1/8	2-3/8	2-5/8	0.139	2.359	± 0.020	3.53	59.92	± 0.51
230	1/8	2-1/2	2-3/4	0.139	2.484	± 0.020	3.53	63.09	± 0.51
231	1/8	2-5/8	2-7/8	0.139	2.609	± 0.020	3.53	66.27	± 0.51
232	1/8	2-3/4	3	0.139	2.734	± 0.024	3.53	69.44	± 0.61
233	1/8	2-7/8	3-1/8	0.139	2.859	± 0.024	3.53	72.62	± 0.61
234	1/8	3	3-1/4	0.139	2.984	± 0.024	3.53	75.79	± 0.61
235	1/8	3-1/8	3-3/8	0.139	3.109	± 0.024	3.53	78.97	± 0.61
236	1/8	3-1/4	3-1/2	0.139	3.234	± 0.024	3.53	82.14	± 0.61
237	1/8	3-3/8	3-5/8	0.139	3.359	± 0.024	3.53	85.32	± 0.61

* RAGCO supports the autonomy of its locations to select the best products to service their markets. Subtle variations of these specification may exist. Contact your RAGCO affiliate for confirmation.

STANDARD O-RING SIZES continued

AS568 SIZE CHART (continued)

AS568	Nominal Reference			Actual Dimensions					
				Inches			Metric		
Dash #	CS (IN)	ID (IN)	OD (IN)	CS	ID	ID Tol	CS	ID	ID Tol
238	1/8	3-1/2	3-3/4	0.139	3.484	± 0.024	3.53	88.49	± 0.61
239	1/8	3-5/8	3-7/8	0.139	3.609	± 0.028	3.53	91.67	± 0.71
240	1/8	3-3/4	4	0.139	3.734	± 0.028	3.53	94.84	± 0.71
241	1/8	3-7/8	4-1/8	0.139	3.859	± 0.028	3.53	98.02	± 0.71
242	1/8	4	4-1/4	0.139	3.984	± 0.028	3.53	101.19	± 0.71
243	1/8	4-1/8	4-3/8	0.139	4.109	± 0.028	3.53	104.37	± 0.71
244	1/8	4-1/4	4-1/2	0.139	4.234	± 0.030	3.53	107.54	± 0.76
245	1/8	4-3/8	4-5/8	0.139	4.359	± 0.030	3.53	110.72	± 0.76
246	1/8	4-1/2	4-3/4	0.139	4.484	± 0.030	3.53	113.89	± 0.76
247	1/8	4-5/8	4-7/8	0.139	4.609	± 0.030	3.53	117.07	± 0.76
248	1/8	4-3/4	5	0.139	4.734	± 0.030	3.53	120.24	± 0.76
249	1/8	4-7/8	5-1/8	0.139	4.859	± 0.035	3.53	123.42	± 0.89
250	1/8	5	5-1/4	0.139	4.984	± 0.035	3.53	126.59	± 0.89
251	1/8	5-1/8	5-3/8	0.139	5.109	± 0.035	3.53	129.77	± 0.89
252	1/8	5-1/4	5-1/2	0.139	5.234	± 0.035	3.53	132.94	± 0.89
253	1/8	5-3/8	5-5/8	0.139	5.359	± 0.035	3.53	136.12	± 0.89
254	1/8	5-1/2	5-3/4	0.139	5.484	± 0.035	3.53	139.29	± 0.89
255	1/8	5-5/8	5-7/8	0.139	5.609	± 0.035	3.53	142.47	± 0.89
256	1/8	5-3/4	6	0.139	5.734	± 0.035	3.53	145.64	± 0.89
257	1/8	5-7/8	6-1/8	0.139	5.859	± 0.035	3.53	148.82	± 0.89
258	1/8	6	6-1/4	0.139	5.984	± 0.035	3.53	151.99	± 0.89
259	1/8	6-1/4	6-1/2	0.139	6.234	± 0.040	3.53	158.34	± 1.02
260	1/8	6-1/2	6-3/4	0.139	6.484	± 0.040	3.53	164.69	± 1.02
261	1/8	6-3/4	7	0.139	6.734	± 0.040	3.53	171.04	± 1.02
262	1/8	7	7-1/4	0.139	6.984	± 0.040	3.53	177.39	± 1.02
263	1/8	7-1/4	7-1/2	0.139	7.234	± 0.045	3.53	183.74	± 1.14
264	1/8	7-1/2	7-3/4	0.139	7.484	± 0.045	3.53	190.09	± 1.14
265	1/8	7-3/4	8	0.139	7.734	± 0.045	3.53	196.44	± 1.14
266	1/8	8	8-1/4	0.139	7.984	± 0.045	3.53	202.79	± 1.14
267	1/8	8-1/4	8-1/2	0.139	8.234	± 0.050	3.53	209.14	± 1.27
268	1/8	8-1/2	8-3/4	0.139	8.484	± 0.050	3.53	215.49	± 1.27
269	1/8	8-3/4	9	0.139	8.734	± 0.050	3.53	221.84	± 1.27
270	1/8	9	9-1/4	0.139	8.984	± 0.050	3.53	228.19	± 1.27
271	1/8	9-1/4	9-1/2	0.139	9.234	± 0.055	3.53	234.54	± 1.40
272	1/8	9-1/2	9-3/4	0.139	9.484	± 0.055	3.53	240.89	± 1.40
273	1/8	9-3/4	10	0.139	9.734	± 0.055	3.53	247.24	± 1.40
274	1/8	10	10-1/4	0.139	9.984	± 0.055	3.53	253.59	± 1.40
275	1/8	10-1/2	10-3/4	0.139	10.484	± 0.055	3.53	266.29	± 1.40
276	1/8	11	11-1/4	0.139	10.984	± 0.065	3.53	278.99	± 1.65
277	1/8	11-1/2	11-3/4	0.139	11.484	± 0.065	3.53	291.69	± 1.65
278	1/8	12	12-1/4	0.139	11.984	± 0.065	3.53	304.39	± 1.65



AS568 SIZE CHART (continued)

AS568	Nominal Reference			Actual Dimensions					
				Inches			Metric		
Dash #	CS (IN)	ID (IN)	OD (IN)	CS	ID	ID Tol	CS	ID	ID Tol
279	1/8	13	13-1/4	0.139	12.984	± 0.065	3.53	329.79	± 1.65
280	1/8	14	14-1/4	0.139	13.984	± 0.065	3.53	355.19	± 1.65
281	1/8	15	15-1/4	0.139	14.984	± 0.065	3.53	380.59	± 1.65
282	1/8	16	16-1/4	0.139	15.955	± 0.075	3.53	405.26	± 1.91
283	1/8	17	17-1/4	0.139	16.955	± 0.080	3.53	430.66	± 2.03
284	1/8	18	18-1/4	0.139	17.955	± 0.085	3.53	456.06	± 2.16
309	3/16	7/16	13/16	0.210	0.412	± 0.005	5.33	10.46	± 0.13
310	3/16	1/2	7/8	0.210	0.475	± 0.005	5.33	12.07	± 0.13
311	3/16	9/16	15/16	0.210	0.537	± 0.007	5.33	13.64	± 0.18
312	3/16	5/8	1	0.210	0.600	± 0.009	5.33	15.24	± 0.23
313	3/16	11/16	1-1/16	0.210	0.662	± 0.009	5.33	16.81	± 0.23
314	3/16	3/4	1-1/8	0.210	0.725	± 0.010	5.33	18.42	± 0.25
315	3/16	13/16	1-3/16	0.210	0.787	± 0.010	5.33	19.99	± 0.25
316	3/16	7/8	1-1/4	0.210	0.850	± 0.010	5.33	21.59	± 0.25
317	3/16	15/16	1-5/16	0.210	0.912	± 0.010	5.33	23.16	± 0.25
318	3/16	1	1-3/8	0.210	0.975	± 0.010	5.33	24.77	± 0.25
319	3/16	1-1/16	1-7/16	0.210	1.037	± 0.010	5.33	26.34	± 0.25
320	3/16	1-1/8	1-1/2	0.210	1.100	± 0.012	5.33	27.94	± 0.30
321	3/16	1-3/16	1-9/16	0.210	1.162	± 0.012	5.33	29.51	± 0.30
322	3/16	1-1/4	1-5/8	0.210	1.225	± 0.012	5.33	31.12	± 0.30
323	3/16	1-5/16	1-11/16	0.210	1.287	± 0.012	5.33	32.69	± 0.30
324	3/16	1-3/8	1-3/4	0.210	1.350	± 0.012	5.33	34.29	± 0.30
325	3/16	1-1/2	1-7/8	0.210	1.475	± 0.015	5.33	37.47	± 0.38
326	3/16	1-5/8	2	0.210	1.600	± 0.015	5.33	40.64	± 0.38
327	3/16	1-3/4	2-1/8	0.210	1.725	± 0.015	5.33	43.82	± 0.38
328	3/16	1-7/8	2-1/4	0.210	1.850	± 0.015	5.33	46.99	± 0.38
329	3/16	2	2-3/8	0.210	1.975	± 0.018	5.33	50.17	± 0.46
330	3/16	2-1/8	2-1/2	0.210	2.100	± 0.018	5.33	53.34	± 0.46
331	3/16	2-1/4	2-5/8	0.210	2.225	± 0.018	5.33	56.52	± 0.46
332	3/16	2-3/8	2-3/4	0.210	2.350	± 0.018	5.33	59.69	± 0.46
333	3/16	2-1/2	2-7/8	0.210	2.475	± 0.020	5.33	62.87	± 0.51
334	3/16	2-5/8	3	0.210	2.600	± 0.020	5.33	66.04	± 0.51
335	3/16	2-3/4	3-1/8	0.210	2.725	± 0.020	5.33	69.22	± 0.51
336	3/16	2-7/8	3-1/4	0.210	2.850	± 0.020	5.33	72.39	± 0.51
337	3/16	3	3-3/8	0.210	2.975	± 0.024	5.33	75.57	± 0.61
338	3/16	3-1/8	3-1/2	0.210	3.100	± 0.024	5.33	78.74	± 0.61
339	3/16	3-1/4	3-5/8	0.210	3.225	± 0.024	5.33	81.92	± 0.61
340	3/16	3-3/8	3-3/4	0.210	3.350	± 0.024	5.33	85.09	± 0.61
341	3/16	3-1/2	3-7/8	0.210	3.475	± 0.024	5.33	88.27	± 0.61
342	3/16	3-5/8	4	0.210	3.600	± 0.028	5.33	91.44	± 0.71
343	3/16	3-3/4	4-1/8	0.210	3.725	± 0.028	5.33	94.62	± 0.71

* RAGCO supports the autonomy of its locations to select the best products to service their markets. Subtle variations of these specification may exist. Contact your RAGCO affiliate for confirmation.

STANDARD O-RING SIZES continued

AS568 SIZE CHART (continued)

AS568	Nominal Reference			Actual Dimensions					
				Inches			Metric		
Dash #	CS (IN)	ID (IN)	OD (IN)	CS	ID	ID Tol	CS	ID	ID Tol
344	3/16	3-7/8	4-1/4	0.210	3.850	± 0.028	5.33	97.79	± 0.71
345	3/16	4	4-3/8	0.210	3.975	± 0.028	5.33	100.97	± 0.71
346	3/16	4-1/8	4-1/2	0.210	4.100	± 0.028	5.33	104.14	± 0.71
347	3/16	4-1/4	4-5/8	0.210	4.225	± 0.030	5.33	107.32	± 0.76
348	3/16	4-3/8	4-3/4	0.210	4.350	± 0.030	5.33	110.49	± 0.76
349	3/16	4-1/2	4-7/8	0.210	4.475	± 0.030	5.33	113.67	± 0.76
350	3/16	4-5/8	5	0.210	4.600	± 0.030	5.33	116.84	± 0.76
351	3/16	4-3/4	5-1/8	0.210	4.725	± 0.030	5.33	120.02	± 0.76
352	3/16	4-7/8	5-1/4	0.210	4.850	± 0.030	5.33	123.19	± 0.76
353	3/16	5	5-3/8	0.210	4.975	± 0.037	5.33	126.37	± 0.94
354	3/16	5-1/8	5-1/2	0.210	5.100	± 0.037	5.33	129.54	± 0.94
355	3/16	5-1/4	5-5/8	0.210	5.225	± 0.037	5.33	132.72	± 0.94
356	3/16	5-3/8	5-3/4	0.210	5.350	± 0.037	5.33	135.89	± 0.94
357	3/16	5-1/2	5-7/8	0.210	5.475	± 0.037	5.33	139.07	± 0.94
358	3/16	5-5/8	6	0.210	5.600	± 0.037	5.33	142.24	± 0.94
359	3/16	5-3/4	6-1/8	0.210	5.725	± 0.037	5.33	145.42	± 0.94
360	3/16	5-7/8	6-1/4	0.210	5.850	± 0.037	5.33	148.59	± 0.94
361	3/16	6	6-3/8	0.210	5.975	± 0.037	5.33	151.77	± 0.94
362	3/16	6-1/4	6-5/8	0.210	6.225	± 0.040	5.33	158.12	± 1.02
363	3/16	6-1/2	6-7/8	0.210	6.475	± 0.040	5.33	164.47	± 1.02
364	3/16	6-3/4	7-1/8	0.210	6.725	± 0.040	5.33	170.82	± 1.02
365	3/16	7	7-3/8	0.210	6.975	± 0.040	5.33	177.17	± 1.02
366	3/16	7-1/4	7-5/8	0.210	7.225	± 0.045	5.33	183.52	± 1.14
367	3/16	7-1/2	7-7/8	0.210	7.475	± 0.045	5.33	189.87	± 1.14
368	3/16	7-3/4	8-1/8	0.210	7.725	± 0.045	5.33	196.22	± 1.14
369	3/16	8	8-3/8	0.210	7.975	± 0.045	5.33	202.57	± 1.14
370	3/16	8-1/4	8-5/8	0.210	8.225	± 0.050	5.33	208.92	± 1.27
371	3/16	8-1/2	8-7/8	0.210	8.475	± 0.050	5.33	215.27	± 1.27
372	3/16	8-3/4	9-1/8	0.210	8.725	± 0.050	5.33	221.62	± 1.27
373	3/16	9	9-3/8	0.210	8.975	± 0.050	5.33	227.97	± 1.27
374	3/16	9-1/4	9-5/8	0.210	9.225	± 0.055	5.33	234.32	± 1.40
375	3/16	9-1/2	9-7/8	0.210	9.475	± 0.055	5.33	240.67	± 1.40
376	3/16	9-3/4	10-1/8	0.210	9.725	± 0.055	5.33	247.02	± 1.40
377	3/16	10	10-3/8	0.210	9.975	± 0.055	5.33	253.37	± 1.40
378	3/16	10-1/2	10-7/8	0.210	10.475	± 0.060	5.33	266.07	± 1.52
379	3/16	11	11-3/8	0.210	10.975	± 0.060	5.33	278.77	± 1.52
380	3/16	11-1/2	11-7/8	0.210	11.475	± 0.065	5.33	291.47	± 1.65
381	3/16	12	12-3/8	0.210	11.975	± 0.065	5.33	304.17	± 1.65
382	3/16	13	13-3/8	0.210	12.975	± 0.065	5.33	329.57	± 1.65
383	3/16	14	14-3/8	0.210	13.975	± 0.070	5.33	354.97	± 1.78
384	3/16	15	15-3/8	0.210	14.975	± 0.070	5.33	380.37	± 1.78



AS568 SIZE CHART (continued)

AS568	Nominal Reference			Actual Dimensions					
				Inches			Metric		
Dash #	CS (IN)	ID (IN)	OD (IN)	CS	ID	ID Tol	CS	ID	ID Tol
385	3/16	16	16-3/8	0.210	15.955	± 0.075	5.33	405.26	± 1.91
386	3/16	17	17-3/8	0.210	16.955	± 0.080	5.33	430.66	± 2.03
387	3/16	18	18-3/8	0.210	17.955	± 0.085	5.33	456.06	± 2.16
388	3/16	19	19-3/8	0.210	18.955	± 0.090	5.33	481.46	± 2.29
389	3/16	20	20-3/8	0.210	19.955	± 0.095	5.33	506.86	± 2.41
390	3/16	21	21-3/8	0.210	20.955	± 0.095	5.33	532.26	± 2.41
391	3/16	22	22-3/8	0.210	21.955	± 0.095	5.33	557.66	± 2.41
392	3/16	23	23-3/8	0.210	22.940	± 0.105	5.33	582.68	± 2.67
393	3/16	24	24-3/8	0.210	23.940	± 0.110	5.33	608.08	± 2.79
394	3/16	25	25-3/8	0.210	24.940	± 0.115	5.33	633.48	± 2.92
395	3/16	26	26-3/8	0.210	25.940	± 0.120	5.33	658.88	± 3.05
400	1/4	1-3/8	1-7/8	0.275	1.350	± 0.012	6.99	34.29	± 0.30
401	1/4	1-1/2	2	0.275	1.475	± 0.015	6.99	37.47	± 0.38
402	1/4	1-5/8	2-1/8	0.275	1.600	± 0.015	6.99	40.64	± 0.38
403	1/4	1-3/4	2-1/4	0.275	1.725	± 0.015	6.99	43.82	± 0.38
404	1/4	1-7/8	2-3/8	0.275	1.850	± 0.015	6.99	46.99	± 0.38
405	1/4	2	2-1/2	0.275	1.975	± 0.018	6.99	50.17	± 0.46
406	1/4	2-1/8	2-5/8	0.275	2.100	± 0.018	6.99	53.34	± 0.46
407	1/4	2-1/4	2-3/4	0.275	2.225	± 0.018	6.99	56.52	± 0.46
408	1/4	2-3/8	2-7/8	0.275	2.350	± 0.018	6.99	59.69	± 0.46
409	1/4	2-1/2	3	0.275	2.475	± 0.020	6.99	62.87	± 0.51
410	1/4	2-5/8	3-1/8	0.275	2.600	± 0.020	6.99	66.04	± 0.51
411	1/4	2-3/4	3-1/4	0.275	2.725	± 0.020	6.99	69.22	± 0.51
412	1/4	2-7/8	3-3/8	0.275	2.850	± 0.020	6.99	72.39	± 0.51
413	1/4	3	3-1/2	0.275	2.975	± 0.024	6.99	75.57	± 0.61
414	1/4	3-1/8	3-5/8	0.275	3.100	± 0.024	6.99	78.74	± 0.61
415	1/4	3-1/4	3-3/4	0.275	3.225	± 0.024	6.99	81.92	± 0.61
416	1/4	3-3/8	3-7/8	0.275	3.350	± 0.024	6.99	85.09	± 0.61
417	1/4	3-1/2	4	0.275	3.475	± 0.024	6.99	88.27	± 0.61
418	1/4	3-5/8	4-1/8	0.275	3.600	± 0.028	6.99	91.44	± 0.71
419	1/4	3-3/4	4-1/4	0.275	3.725	± 0.028	6.99	94.62	± 0.71
420	1/4	3-7/8	4-3/8	0.275	3.850	± 0.028	6.99	97.79	± 0.71
421	1/4	4	4-1/2	0.275	3.975	± 0.028	6.99	100.97	± 0.71
422	1/4	4-1/8	4-5/8	0.275	4.100	± 0.028	6.99	104.14	± 0.71
423	1/4	4-1/4	4-3/4	0.275	4.225	± 0.030	6.99	107.32	± 0.76
424	1/4	4-3/8	4-7/8	0.275	4.350	± 0.030	6.99	110.49	± 0.76
425	1/4	4-1/2	5	0.275	4.475	± 0.033	6.99	113.67	± 0.84
426	1/4	4-5/8	5-1/8	0.275	4.600	± 0.033	6.99	116.84	± 0.84
427	1/4	4-3/4	5-1/4	0.275	4.725	± 0.033	6.99	120.02	± 0.84
428	1/4	4-7/8	5-3/8	0.275	4.850	± 0.033	6.99	123.19	± 0.84
429	1/4	5	5-1/2	0.275	4.975	± 0.037	6.99	126.37	± 0.94

* RAGCO supports the autonomy of its locations to select the best products to service their markets. Subtle variations of these specification may exist. Contact your RAGCO affiliate for confirmation.

STANDARD O-RING SIZES continued

AS568 SIZE CHART (continued)

AS568	Nominal Reference			Actual Dimensions					
				Inches			Metric		
Dash #	CS (IN)	ID (IN)	OD (IN)	CS	ID	ID Tol	CS	ID	ID Tol
430	1/4	5-1/8	5-5/8	0.275	5.100	± 0.037	6.99	129.54	± 0.94
431	1/4	5-1/4	5-3/4	0.275	5.225	± 0.037	6.99	132.72	± 0.94
432	1/4	5-3/8	5-7/8	0.275	5.350	± 0.037	6.99	135.89	± 0.94
433	1/4	5-1/2	6	0.275	5.475	± 0.037	6.99	139.07	± 0.94
434	1/4	5-5/8	6-1/8	0.275	5.600	± 0.037	6.99	142.24	± 0.94
435	1/4	5-3/4	6-1/4	0.275	5.725	± 0.037	6.99	145.42	± 0.94
436	1/4	5-7/8	6-3/8	0.275	5.850	± 0.037	6.99	148.59	± 0.94
437	1/4	6	6-1/2	0.275	5.975	± 0.037	6.99	151.77	± 0.94
438	1/4	6-1/4	6-3/4	0.275	6.225	± 0.040	6.99	158.12	± 1.02
439	1/4	6-1/2	7	0.275	6.475	± 0.040	6.99	164.47	± 1.02
440	1/4	6-3/4	7-1/4	0.275	6.725	± 0.040	6.99	170.82	± 1.02
441	1/4	7	7-1/2	0.275	6.975	± 0.040	6.99	177.17	± 1.02
442	1/4	7-1/4	7-3/4	0.275	7.225	± 0.045	6.99	183.52	± 1.14
443	1/4	7-1/2	8	0.275	7.475	± 0.045	6.99	189.87	± 1.14
444	1/4	7-3/4	8-1/4	0.275	7.725	± 0.045	6.99	196.22	± 1.14
445	1/4	8	8-1/2	0.275	7.975	± 0.045	6.99	202.57	± 1.14
446	1/4	8-1/2	9	0.275	8.475	± 0.055	6.99	215.27	± 1.40
447	1/4	9	9-1/2	0.275	8.975	± 0.055	6.99	227.97	± 1.40
448	1/4	9-1/2	10	0.275	9.475	± 0.055	6.99	240.67	± 1.40
449	1/4	10	10-1/2	0.275	9.975	± 0.055	6.99	253.37	± 1.40
450	1/4	10-1/2	11	0.275	10.475	± 0.060	6.99	266.07	± 1.52
451	1/4	11	11-1/2	0.275	10.975	± 0.060	6.99	278.77	± 1.52
452	1/4	11-1/2	12	0.275	11.475	± 0.060	6.99	291.47	± 1.52
453	1/4	12	12-1/2	0.275	11.975	± 0.060	6.99	304.17	± 1.52
454	1/4	12-1/2	13	0.275	12.475	± 0.060	6.99	316.87	± 1.52
455	1/4	13	13-1/2	0.275	12.975	± 0.060	6.99	329.57	± 1.52
456	1/4	13-1/2	14	0.275	13.475	± 0.070	6.99	342.27	± 1.78
457	1/4	14	14-1/2	0.275	13.975	± 0.070	6.99	354.97	± 1.78
458	1/4	14-1/2	15	0.275	14.475	± 0.070	6.99	367.67	± 1.78
459	1/4	15	15-1/2	0.275	14.975	± 0.070	6.99	380.37	± 1.78
460	1/4	15-1/2	16	0.275	15.475	± 0.070	6.99	393.07	± 1.78
461	1/4	16	16-1/2	0.275	15.955	± 0.075	6.99	405.26	± 1.91
462	1/4	16-1/2	17	0.275	16.455	± 0.075	6.99	417.96	± 1.91
463	1/4	17	17-1/2	0.275	16.955	± 0.080	6.99	430.66	± 2.03
464	1/4	17-1/2	18	0.275	17.455	± 0.085	6.99	443.36	± 2.16
465	1/4	18	18-1/2	0.275	17.955	± 0.085	6.99	456.06	± 2.16
466	1/4	18-1/2	19	0.275	18.455	± 0.085	6.99	468.76	± 2.16
467	1/4	19	19-1/2	0.275	18.955	± 0.090	6.99	481.46	± 2.29
468	1/4	19-1/2	20	0.275	19.455	± 0.090	6.99	494.16	± 2.29
469	1/4	20	20-1/2	0.275	19.955	± 0.095	6.99	506.86	± 2.41
470	1/4	21	21-1/2	0.275	20.955	± 0.095	6.99	532.26	± 2.41



O-RING &
O-RING CORD

* RAGCO supports the autonomy of its locations to select the best products to service their markets. Subtle variations of these specification may exist. Contact your RAGCO affiliate for confirmation.

AS568 SIZE CHART (continued)

AS568	Nominal Reference			Actual Dimensions					
				Inches			Metric		
Dash #	CS (IN)	ID (IN)	OD (IN)	CS	ID	ID Tol	CS	ID	ID Tol
471	1/4	22	22-1/2	.275	21.955	± .100	6.99	557.66	± 2.54
472	1/4	23	23-1/2	.275	22.940	± .105	6.99	582.68	± 2.67
473	1/4	24	24-1/2	.275	23.940	± .110	6.99	608.08	± 2.79
474	1/4	25	25-1/2	.275	24.940	± .115	6.99	633.48	± 2.92
475	1/4	26	26-1/2	.275	25.940	± .120	6.99	658.88	± 3.05
901				.056	.185	± .005	1.42	4.70	± .13
902				.064	.239	± .005	1.63	6.07	± .13
903				.064	.301	± .005	1.63	7.65	± .13
904				.072	.351	± .005	1.83	8.92	± .13
905				.072	.414	± .005	1.83	10.52	± .13
906				.078	.468	± .005	1.98	11.89	± .13
907				.082	.530	± .007	2.08	13.46	± .18
908				.087	.644	± .009	2.21	16.36	± .23
909				.097	.706	± .009	2.46	17.93	± .23
910				.097	.755	± .009	2.46	19.18	± .23
911				.116	.863	± .009	2.95	21.92	± .23
912				.116	.924	± .009	2.95	23.47	± .23
913				.116	.986	± .010	2.95	25.04	± .25
914				.116	1.047	± .010	2.95	26.59	± .25
916				.116	1.171	± .010	2.95	29.74	± .25
918				.116	1.355	± .012	2.95	34.42	± .30
920				.118	1.475	± .014	3.00	37.47	± .36
924				.118	1.720	± .014	3.00	43.69	± .36
928				.118	2.090	± .018	3.00	53.09	± .46
932				.118	2.337	± .018	3.00	59.36	± .46

* RAGCO supports the autonomy of its locations to select the best products to service their markets. Subtle variations of these specification may exist. Contact your RAGCO affiliate for confirmation.



STANDARD O-RING CORD

NOMINAL CROSS SECTION (IN)	ACTUAL CROSS SECTION (IN)	TOLERANCE (IN)
1/16	0.063	0.005
1/16	0.070	0.007
3/32	0.093	0.007
3/32	0.103	0.007
1/8	0.125	0.007
1/8	0.139	0.007
3/16	0.188	0.007
3/16	0.210	0.007
1/4	0.250	0.008
1/4	0.275	0.008
5/16	0.313	0.008
3/8	0.375	0.010
7/16	0.437	0.012
1/2	0.500	0.015
9/16	0.562	0.015
5/8	0.625	0.015
3/4	0.750	0.015
7/8	0.875	0.020
1	1.000	0.020
1 1/16	1.062	0.030
1 1/8	1.125	0.030
1 1/4	1.250	0.040
1 1/2	1.500	0.060

METRIC O-RING CORD

DIAMETER (MM)	DIAMETER (IN)	TOLERANCE (MM)
2.0	0.079	+/- 0.10
2.5	0.098	+/- 0.10
3.0	0.118	+/- 0.12
3.5	0.139	+/- 0.15
4.0	0.158	+/- 0.15
4.5	0.177	+/- 0.15
5.0	0.197	+/- 0.20
5.7	0.224	+/- 0.25
6.0	0.236	+/- 0.25
7.0	0.275	+/- 0.25
7.5	0.295	+/- 0.25
8.4	0.330	+/- 0.25
9.0	0.354	+/- 0.25
10.0	0.393	+/- 0.25
12.0	0.472	+/- 0.45
14.0	0.550	+/- 0.50

STANDARD O-RING KIT

70 DURO BLACK 30 SIZES, 382 PCS AS568 STANDARD SIZES



This kit contains 382 O-Rings in the 30 most popular sizes, providing an extremely low cost per size value. O-Rings conform dimensionally to AS568 universal series. **Standard kit material is 70-duro buna.** Kits are available in a wide variety of compounds and durometers.

KIT CONTENTS

DASH #	KIT QTY	NOMINAL REF			ACTUAL SIZE	
		CS	ID	OD	CS	ID
-006	20	1/16	1/8	1/4	.070"	.114"
-007	20	1/16	5/32	9/32	.070"	.145"
-008	20	1/16	3/16	5/16	.070"	.176"
-009	20	1/16	7/32	11/32	.070"	.208"
-010	20	1/16	1/4	3/8	.070"	.239"
-011	20	1/16	5/16	7/16	.070"	.301"
-012	20	1/16	3/8	1/2	.070"	.364"
-110	13	3/32	3/8	9/16	.103"	.362"
-111	13	3/32	7/16	5/8	.103"	.424"
-112	13	3/32	1/2	11/16	.103"	.487"
-113	13	3/32	9/16	3/4	.103"	.549"
-114	13	3/32	5/8	13/16	.103"	.612"
-115	13	3/32	11/16	7/8	.103"	.674"
-116	13	3/32	3/4	15/16	.103"	.737"
-210	10	1/8	3/4	1	.139"	.734"
-211	10	1/8	13/16	1-1/16	.139"	.796"
-212	10	1/8	7/8	1-1/8	.139"	.859"
-213	10	1/8	15/16	1-3/16	.139"	.921"
-214	10	1/8	1	1-1/4	.139"	.984"
-215	10	1/8	1-1/16	1-5/16	.139"	1.046"
-216	10	1/8	1-1/8	1-3/8	.139"	1.109"
-217	10	1/8	1-3/16	1-7/16	.139"	1.171"
-218	10	1/8	1-1/4	1-1/2	.139"	1.234"
-219	10	1/8	1-5/16	1-9/16	.139"	1.296"
-220	10	1/8	1-3/8	1-5/8	.139"	1.359"
-221	10	1/8	1-7/16	1-11/16	.139"	1.421"
-222	10	1/8	1-1/2	1-3/4	.139"	1.484"
-325	7	3/16	1-1/2	1-7/8	.210"	1.475"
-326	7	3/16	1-5/8	2	.210"	1.600"
-327	7	3/16	1-3/4	2-1/8	.210"	1.725"

* RAGCO supports the autonomy of its locations to select the best products to service their markets. Subtle variations of these specification may exist. Contact your RAGCO affiliate for confirmation.



METRIC O-RING KIT

70 DURO BLACK 32 SIZES, 401 PCS METRIC SIZES

This Metric O-Ring kit contains 401, 70 Durometer O-Rings in 32 different sizes mostly used in industrial and automotive type applications. An extremely valuable kit to have in the warehouse or maintenance department.

Standard kit material is 70-duro buna. Kits are available in a wide variety of compounds and durometers.

KIT CONTENTS

ACTUAL SIZE		KIT QTY
CS	ID	
1	3	19
1	3	19
1	4	17
2	5	9
2	6	17
2	8	17
2	10	17
2	11	17
2	12	17
2	14	17
2	17	17
2	20	17
3	10	12
3	12	12
3	16	12
3	18	12
3	22	12
4	20	9
4	22	9
4	24	9
4	25	9
4	30	9
4	34	9
4	36	9
4	40	9
4	45	9
4	47	9
4	50	9
5	16	7
5	25	7
5	25	7
5	30	7
5	32	7
5	35	7



NITRILE SPLICING KIT

70 DURO BLACK 5 PIECES, 7 FEET EACH

The splicing kit for on the job repairs with rapid set adhesives. This Splicing kit will enable you to construct rings to your custom requirements. There are no special skills required, just follow instructions. This kit contains everything you need to produce a perfect o-ring. Standard kit material is 70-duro buna. Kits are available in a wide variety of compounds and durometers.



CONTENTS

- Stock of O-ring Cord
- Razor Blade
- Cutting JIG
- Tube of Adhesive
- Instructional Card

LENGTH (FT)	CS (IN)	CS (MM)
7	.070	1.78
7	.103	2.62
7	.139	3.53
7	.210	5.33
7	.275	6.99

* RAGCO supports the autonomy of its locations to select the best products to service their markets. Subtle variations of these specification may exist. Contact your RAGCO affiliate for confirmation.

SHEET RUBBER GENERAL PROPERTIES

GENERAL PROPERTIES OF COMMON POLYMERS USED IN SHEET RUBBER

	NEOPRENE	NITRILE	EPDM	SBR	CI	GUM	SILICONE	VITON® (FLUORCARBON)	HYPALON
Heat Aging	Good	Good	Excellent	Good	Good	Good	Excellent	Excellent	Good
Abreasion Resistance	Excellent	Excellent	Excellent	Good	Good	Excellent	Poor	Fair	Fair
Compression Set	Fair	Fair	Fair	Good	Good	Good	Fair	Good	Good
Relilience	Excellent	Good	Good	Good	Good	Excellent	Fair	Fair	Fair
Tear Resistance	Good	Good	Good	Fair	Good	Good	Good	Fair	Fair
Flame Resistance	Excellent	Poor	Very Poor	Very Poor	Very poor	Very Poor	Fair	Good	Good
Weathering	Excellent	Fair	Excellent	Fair	Fair	Fair	Good	Excellent	Excellent
Ozone Resistance	Excellent	Very Poor	Good	Fair	Fair	Poor	Good	Excellent	Excellent
Gas Permeability Resistance	Good	Good	Good	Good	Good	Good	Poor	Poor	Poor
Oil Resistance	Good	Excellent	Very Poor	Poor	Poor	Very Poor	Fair	Good	Fair
Gas Resistance	Good	Excellent	Very Poor	Poor	Poor	Very Poor	Poor	Poor	Poor
Acid Resistance	Good	Good	Good	Fair	Fair	Good	Poor	Good	Good
Alkali Resistance	Good	Good	Good	Fair	Fair	Good	Poor	Good	Good

SHEET RUBBER THICKNESS TOLERANCES

SHEET RUBBER THICKNESS TOLERANCES

NOMINAL THICKNESS			TOLERANCES (PLUS OR MINUS)	
INCHES		MILLIMETERS	INCHES	MILLIMETERS
FRACTIONS	DECIMALS			
Under 1/32	Under 0.031	Under 0.79	0.01	0.25
1/32 to but not including 1/16	0.031 – 0.062	0.79 – 1.59	0.012	0.3
1/16 to but not including 1/8	0.062 – 0.125	1.59 – 3.18	0.016	0.4
1/8 to but not including 3/16	0.125 – 0.187	3.18 – 4.80	0.02	0.51
3/16 to but not including 3/8	0.187 – 0.375	4.80 – 9.50	0.031	0.79
3/8 to but not including 9/16	0.375 – 0.562	9.50 – 14.30	0.047	1.19
9/16 to but not including 3/4	0.562 – 0.750	14.30 – 19.20	0.062	1.59
3/4 to but not including 1	0.750 – 1.000	19.20 – 25.40	0.094	2.38
1 and over	1.000 and over	25.40	10%	10%

* RAGCO supports the autonomy of its locations to select the best products to service their markets. Subtle variations of these specification may exist. Contact your RAGCO affiliate for confirmation.

STORAGE OF RUBBER PRODUCTS

In the following we want to provide our customers with guidelines which enable them to avoid adverse effects on our products in order to ensure a long usability. Uncured compounds have a limited shelf life. The expiry date of PTE rubber compounds is indicated as "next inspection" close to the production date on the pallet label accompanying each delivery.

An expiration of this date does not automatically mean that the compound cannot be used anymore, but that further durability tests are necessary. PTE will guarantee the usability of the delivered compounds for the previously agreed application or product until the indicated expiry date, in case the following instructions for transport and storage have been abode.

The storage conditions of rubber compounds directly influence the workability. Environmental influences such as heat, low temperature, humidity and light during storage may have an essential effect on the processing and quality. When storing our products it should comply with the norms DIN 7716 and ISO 2230.

We draw particular attention to the following points:

Stockroom exchange based on a first-in first-out method (FIFO).

The storage room for compounds must be cool, dry and dust-free.

Storage temperature should range between +15 and +25°C. With higher temperatures the material may start to vulcanize prematurely (scorch). Too low temperatures will make the material stiff and will reduce the adhesion.

Avoid storage places near sources of heat or heating elements. In exceptional cases it is quite acceptable to warm up the material for a short time to a maximum temperature of 50°C before the actual processing in order to improve the adhesion.

Ideally, the air humidity in the storage room should be below 65%. The storage of products in humid rooms must be avoided, and condensation should not be allowed.

Light can damage the products and may lead to a premature ageing. Therefore, products should be protected in particular against direct sunlight and strong artificial light with a high ultraviolet content.

The products must also be protected against powerful ventilation, and in particular against draughts.

Under no circumstances should fuels, lubricants, acids, disinfectants, solvents or other chemicals be stored in the same storage area.

KEEP THE STORAGE PLACE CLEAN.

PROTECT THE MATERIAL FROM DUST, WATER, ETC... WITH SUITABLE COVERINGS.



SAE SHELF LIFE

In 1998, the Society of Aerospace Engineers (SAE) issued Aerospace Recommended Practice (ARP) 5316. It was intended to fully replace MIL_HDBK-695C as the industry standard for the Shelf Life of Aerospace elastomeric seals. However, ARP 5316 can also be used as a useful guideline for Shelf Life of many industrial and commercial grade elastomers as well.

The information in ARP 5316, and the chart below, is intended to be utilized by those organizations who do not already have specific recommendations for the control of elastomeric seals.

It should be noted that the packaging of the elastomeric seals prior to assembly into a product is an integral part of the controlled storage procedure. It provides a positive means of product identity from the time of manufacture, to the time of assembly.

ARP 5316 does not establish limitations for storage times in assembled components, nor does it in any way provide a guideline for the operating life span of a particular compound.

ELASTOMER FAMILY	ASTM ABBREVIATION	ARP 5316 RECOMMENDED SHELF LIFE
Aflas®	—	Unlimited
Butyl Rubber, Isobutylene Isoprene	IIR	Unlimited
Chloroprene (Neoprene®)	CR	3 – 4 Years
Epichlorohydrin (Hydrin®)	ECO	NA
Ethylene Acrylic (Vamac®)	—	3 – 4 Years
Ethylene Propylene, DPDM or EP	EP	Unlimited
Fluorocarbon (Viton®)	FKM	Unlimited
Fluorsilicone	FVMQ	Unlimited
Hydrogenated Nitrile, HMBR or HSN	HNBR	3 – 4 Years
Nitrile (Buna-N or NBR)	NBR	3 – 4 Years
Polyacrylate	VCM	3 – 4 Years
Polyurethane (Polyester or Polyether)	AU / EU	5 Years
Silicone	VMQ	Unlimited
Styrene Butadiene (Buna-S)	SBR	3 – 4 Years

The data shown here are shown as an engineering guide only and should not be used for the purpose of establishing performance limits. These values were obtained using established standard test procedures and are believed to be reliable. However, due to the variables that may be encountered in actual use, it is always advisable to test the material under actual service conditions before specification.

* RAGCO supports the autonomy of its locations to select the best products to service their markets. Subtle variations of these specification may exist. Contact your RAGCO affiliate for confirmation.

TORQUE TABLE

SIZE SELECTION/TORQUES REQUIRED TO SEAL ANSI 150LB FLANGES

NOMINAL FLANGE SIZE (IN)	NUMBER BOTS (N)	BOLT SIZE (IN)	*APROX. SEALEX LENGTH (IN)	SUGGESTED SEALEX SIZE (IN)	SEALING STRESS (LBS/IN)	TORQUE (LB/FT)
1/2	4	0.5	4.3	3/16	1570	30
3/4	4	0.5	5.2	3/16	1570	30
1	4	0.5	6.2	3/16	1570	30
1-1/4	4	0.5	7.4	3/16	1570	30
1-1/2	4	0.5	8.3	1/4	2140	30
2	4	0.625	10.2	1/4	2140	60
2-1/2	4	0.625	12.2	1/4	2140	60
3	4	0.625	13.9	1/4	2140	60
4	8	0.625	17.9	3/8	2620	60
5	8	0.75	20.9	3/8	2760	100
6	8	0.75	24.1	3/8	2625	100
8	8	0.75	30.9	3/8	2625	100
10	12	0.875	37.9	3/8	2750	160
12	12	0.875	45.4	1/2	3000	160



METRIC CONVERSIONS

INCHES		METRIC
FRACTIONAL	DECIMAL	MM
	0.0039	0.1
	0.0079	0.2
	0.0118	0.3
1/64	0.0156	0.3969
	0.0157	0.4
	0.0197	0.5
	0.0236	0.6
	0.0276	0.7
3/64	0.0313	0.7938
	0.0315	0.8
	0.0354	0.9
	0.0394	1
	0.0433	1.1
	0.0469	1.1906
	0.0472	1.2
	0.0512	1.3
	0.0551	1.4
	0.0591	1.5
1/16	0.0625	1.5875
	0.063	1.6
	0.0669	1.7
	0.0709	1.8
	0.0748	1.9
5/64	0.0781	1.9844
	0.0787	2
	0.0827	2.1
	0.0866	2.2
	0.0906	2.3
3/32	0.0938	2.3813
	0.0945	2.4
	0.0984	2.5
7/64	0.1094	2.7781
	0.1181	3
1/8	0.125	3.175
	0.1378	3.5
9/64	0.1406	3.5719
5/32	0.1563	3.9688
	0.1575	4
10/64	0.1719	4.3656
	0.1772	4.5
3/16	0.1875	4.7625

INCHES		METRIC
FRACTIONAL	DECIMAL	MM
.	0.1969	5
13/64	0.2031	5.1594
.	0.2165	5.5
7/32	0.2188	5.5563
15/64	0.2344	5.9531
.	0.2362	6
1/4	0.25	6.35
.	0.2559	6.5
17/64	0.2656	6.7469
.	0.2756	7
9/32	0.2813	7.1438
.	0.2953	7.5
19/64	0.2969	7.5406
5/16	0.3125	7.9375
.	0.315	8
21/64	0.3281	8.3344
.	0.3346	8.5
9/32	0.3438	8.7313
.	0.3543	9
23/64	0.3594	9.1281
.	0.374	9.5
3/8	0.375	9.525
25/64	0.3906	9.9219
.	0.3937	10
13/32	0.4063	10.3188
.	0.4134	10.5
27/64	0.4219	10.7156
.	0.4331	11
7/16	0.4375	11.1125
.	0.4528	11.5
29/64	0.4531	11.5094
15/32	0.4688	11.9063
.	0.4724	12
31/64	0.4844	12.3031
.	0.4921	12.5
1/2	0.5	12.7
.	0.5118	13
33/64	0.5156	13.0969
17/32	0.5313	13.4938
.	0.5315	13.5
35/64	0.5469	13.8906

INCHES		METRIC
FRACTIONAL	DECIMAL	MM
.	0.5512	14
9/16	0.5625	14.2875
.	0.5709	14.5
37/64	0.5781	14.6844
.	0.5906	15
19/32	0.5938	15.0813
39/64	0.6094	15.4781
.	0.6102	15.5
5/8	0.625	15.875
.	0.6299	16
41/64	0.6406	16.2719
.	0.6496	16.5
21/32	0.6563	16.6688
.	0.6693	17
43/64	0.6719	17.0656
11/16	0.6875	17.4625
.	0.689	17.5
45/64	0.7031	17.8594
.	0.7087	18
23/32	0.7188	18.2563
.	0.7283	18.5
47/64	0.7344	18.6531
.	0.748	19
3/4	0.75	19.05
49/64	0.7656	19.4469
.	0.7677	19.5
25/32	0.7813	19.8438
.	0.7874	20
51/64	0.7969	20.2406
.	0.8071	20.5
13/16	0.8125	20.6375
.	0.8268	21
53/64	0.8281	21.0344
27/32	0.8438	21.4313
.	0.8465	21.5
55/64	0.8594	21.8281
.	0.8661	22
7/8	0.875	22.225
.	0.8858	22.5
57/64	0.8906	22.6219
.	0.9055	23

* RAGCO supports the autonomy of its locations to select the best products to service their markets. Subtle variations of these specification may exist. Contact your RAGCO affiliate for confirmation.



METRIC CONVERSIONS continued

INCHES		METRIC
FRACTIONAL	DECIMAL	MM
29/32	0.9063	23.0188
59/64	0.9219	23.4156
.	0.9252	23.5
15/16	0.9375	23.8125
.	0.9449	24
61/64	0.9531	24.2094
.	0.9646	24.5
31/32	0.9688	24.6063
.	0.9843	25
63/64	0.9844	25.0031
1	1	25.4
.	1.0039	25.5
.	1.0236	26
.	1.0433	26.5
.	1.063	27
.	1.0827	27.5
.	1.1024	28
.	1.122	28.5
.	1.1417	29
.	1.1614	29.5
.	1.1811	30
.	1.2205	31
1 1/4	1.25	31.75
.	1.2598	32
.	1.2992	33
.	1.3386	34
.	1.378	35
.	1.4173	36
.	1.4567	37
.	1.4961	38
1 1/2	1.5	38.1
.	1.5354	39
.	1.5748	40
.	1.6142	41
.	1.6535	42
.	1.6929	43
.	1.7323	44
1 3/4	1.75	44.45
.	1.7717	45
.	1.811	46
.	1.8504	47

INCHES		METRIC
FRACTIONAL	DECIMAL	MM
.	1.8898	48
.	1.9291	49
.	1.9685	50
2	2	50.8
.	2.0079	51
.	2.0472	52
.	2.0866	53
.	2.126	54
.	2.1654	55
.	2.2047	56
.	2.2441	57
2 1/4	2.25	57.15
.	2.2835	58
.	2.3228	59
.	2.3622	60
.	2.4016	61
.	2.4409	62
.	2.4803	63
2 1/2	2.5	63.5
.	2.5197	64
.	2.5591	65
.	2.5984	66
.	2.6378	67
.	2.6772	68
.	2.7165	69
2 3/4	2.75	69.85
.	2.7559	70
.	2.7953	71
.	2.8346	72
.	2.874	73
.	2.9134	74
.	2.9528	75
.	2.9921	76
3	3	76.2
.	3.0315	77
.	3.0709	78
.	3.1102	79
.	3.1496	80
.	3.189	81
.	3.2283	82
.	3.2677	83

INCHES		METRIC
FRACTIONAL	DECIMAL	MM
.	3.3071	84
.	3.3465	85
.	3.3858	86
.	3.4252	87
.	3.4646	88
3 1/2	3.5	88.9
.	3.5039	89
.	3.5433	90
.	3.5827	91
.	3.622	92
.	3.6614	93
.	3.7008	94
.	3.7402	95
.	3.7795	96
.	3.8189	97
.	3.8583	98
.	3.8976	99
.	3.937	100
4	4	101.6
.	4.3307	110
4 1/2	4.5	114.3
.	4.7244	120
5	5	127
.	5.1181	130
.	5.5118	140
.	5.9055	150
6	6	152.4
.	6.2992	160
.	6.6929	170
.	7.0866	180
.	7.4803	190
.	7.874	200
8	8	203.2
.	9.8425	250
10	10	254
20	20	508
30	30	762
40	40	1016
60	60	1524
80	80	2032
100	100	2540





CONTACT US TO FIND YOUR RAGCO AFFILIATE

RAGCO.COM

